

**REFLEX RADAR  
FMCW-VG6  
FMCW-VG7  
FMCW-VG5**

**RADAR TYPE LEVEL METER ( Frequency Modulated Continuous Wave )**



Applicable to liquid & solid etc.

Sheet Horn Antenna,  
which improves measuring range, released.

A representative of Non-contact level indicator!  
Stable and reliable measurement realized  
by a prominent software

# FMCW-VG6 / FMCW-VG7/ FMCW-VG5

FMCW ▶ Frequency Modulated Continuous Wave

## Non-Contact Radar Level Meter

Unaffected by Temperature, Pressure and Change in Dielectric-Constant and Density. Applicable to Various Application.

Frequency Modulated Continuous Wave Type is the best measurement way to have high repeatability and high resolution.

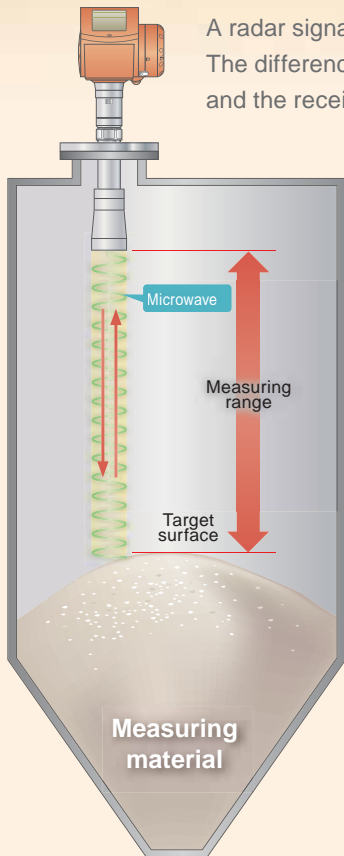

A radar signal is transmitted and reflected from the target surface at a time-delayed frequency. The difference in these frequencies are calculated from the difference between the transmitted frequency and the received frequency. This difference is directly proportional to the distance measured.

### Feature

- Applicable to powders, granules, slurries, pastes
- Unaffected by measuring material change
- Measuring range up to 80m (VG6)
- Applicable to vacuum condition, high temperature, high pressure
- ATEX EExia (Intrinsic safety)
- 2 Wire loop type

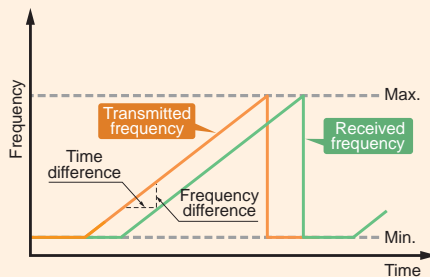

### VG6/7 Advantage

- ETS (Empty Tank Spectrum) ... can be utilized to damp out all unwanted reflections from pipes heating coils and agitator.
- TBF (Tank Bottom Following) ..... enables products with dielectric constants as low as min. 1.5 to be measured.
- Compatibility in head and antenna ... Head and antenna part are compatible. Only antenna part can be exchanged if there happens some change in application.

### Internal Terminal

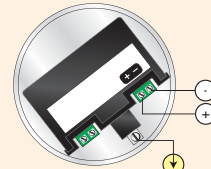

Power Supply	DC24V
Output	DC4 ~ 20mA(HART Communication)
Error Signal	3.8mA/22mA/Hold

### Connection Diagram

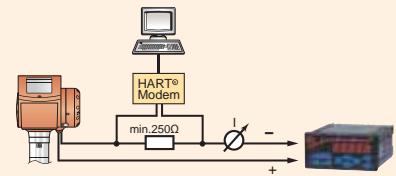

## Unique Designed Antenna

Drop Antenna Adhesion resistant	Sheet Horn Antenna Long span measurement	Compact Horn Antenna

Various application can be covered with these 3 antennas.

**Connection Diagram** (VG6/VG7 Common)

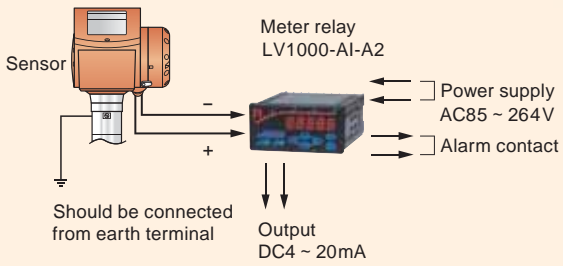

**ATEX**  
EExia CT6

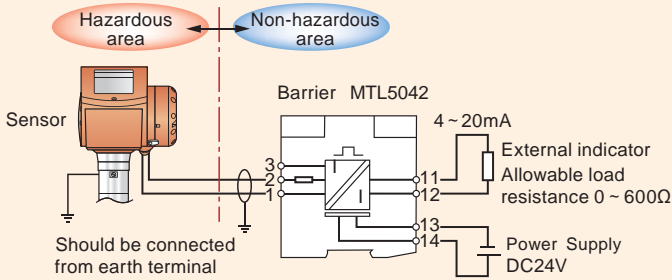

**Whether Proof Cover**

Whether proof cover (option) use is recommended for display outside use to avoid direct sunlight.

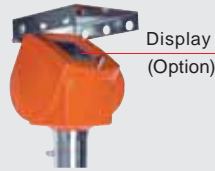

**Measurement with Bulwark Pipe**

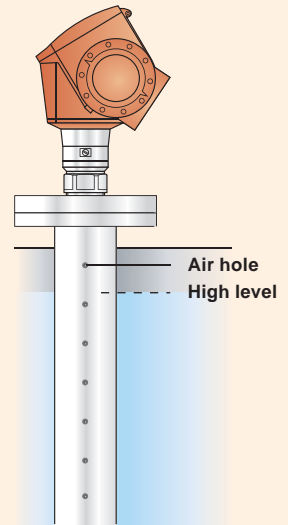

Bulwark pipe, which provides stable measurement, is recommended for application such as bullet tank, obstacles inside the tank and unstable target surface.

**MTL5042 Terminal Number**

Terminal Number	Function
1	Power Input Terminal
2	Transmitter Power(+V)
3	Common
11	Current Output(-)
12	Current Output(+)
13	Power(-V)
14	Power(+V)

**Setting** Parameter setting and condition monitoring is available with display on sensor head and HART communication PC.

**Interactive mode sensor head display;**



Setting can be controlled on the sensor head button as shown below.

**Setting on HART communication PC( PC display )**

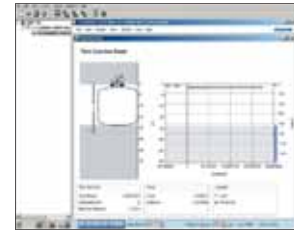
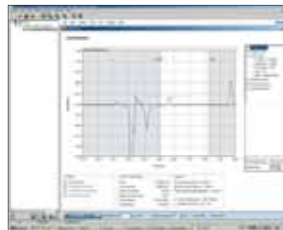

Level measurement: 16.345m

Distance measurement: Ullage 16.345m

Total amount measurement: Weight 2.04 tons

Space volume measurement: Vapor weight 3.70 tons

Reflectance measurement: Back up on the numeric display 51%

Signal spectrum measurement: Distance 0.474, Sample 7208

Level 16.345m

Ullage 16.345m

Weight 2.04 tons

Vapor weight 3.70 tons

Level 64%

Ullage 36%

Weight 27%

Vapor weight 25%

Back up on the numeric display

Sensor head display

(Option)

# FMCW-VG6

FMCW ▶ Frequency Modulated Continuous Wave

Powder · Granule Measurement

Software to catch the powder surface certainly

Max. Measuring range 60m depending on application and antenna type

## Drop Antenna Series

### VG6 0 P/S 1~5

【DN 8 0】with extension

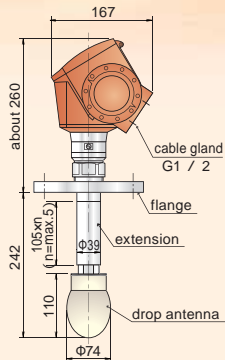

### VG6 0 P/SP/S

【DN 8 0】with flange plate protection

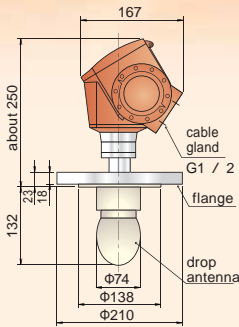

### VG6 0T1~5

【DN 1 5 0】with extension

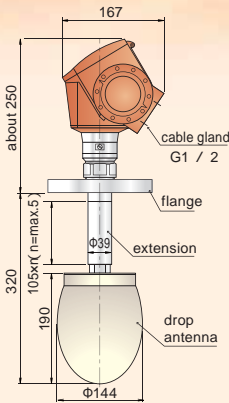

### VG6 0 P/SP/S

【DN 8 0】with flange plate protection

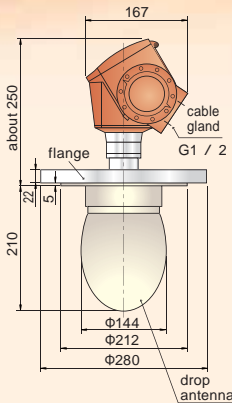

### VG6 0V0

【DN 8 0】with air purge system

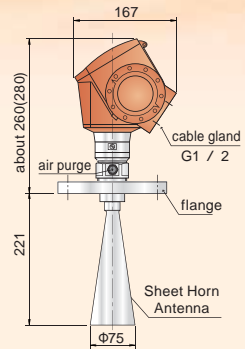

Antenna	PP / PTFE
Beam angle	4°(half angle)
Measuring range	30m(depends on application)
Dead band	0.3m from antenna top (depends on application)
Pressure	PP: 1.6MPa PTFE: 4.0MPa
Temperature	PP: 100 (Seal material :FKM) PTFE: 150 (Seal material :FKM)

Antenna	PP / PTFE
Beam angle	4°(half angle)
Measuring range	30m(depends on application)
Dead band	0.3m from antenna top (depends on application)
Pressure	PP: 1.6MPa PTFE: 4.0MPa
Temperature	PP: 100 (Seal material :FKM) PTFE: 150 (Seal material :FKM)

Antenna	PP
Beam angle	2°(half angle)
Measuring range	60m(depends on application)
Dead band	0.3m from antenna top (depends on application)
Pressure	1.6MPa
Temperature	PP: 100 (Seal material :FKM)

Antenna	PP
Beam angle	2°(half angle)
Measuring range	60m(depends on application)
Dead band	0.3m from antenna top (depends on application)
Pressure	1.6MPa
Temperature	PP: 100 (Seal material :FKM)

Antenna	SUS316L
Beam angle	5°(half angle)
Measuring range	30m(depends on application)
Dead band	0.3m from antenna top (depends on application)
Pressure	4.0MPa
Temperature	PP: 200 (Seal material :FKM)

## Sheet Horn Antenna Series

### VG6 0V 1~B

【DN 8 0】with extension and air purge system

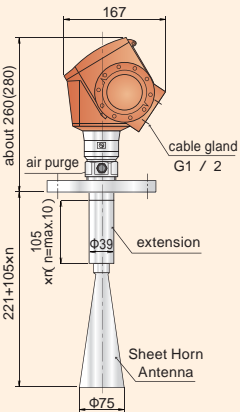

### VG6 0W0

【DN 1 0 0】with air purge system

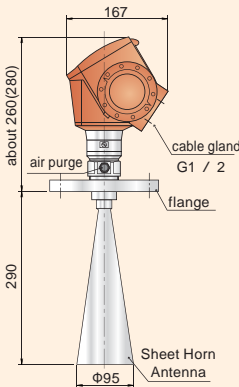

### VG6 0W 1~5

【DN 1 0 0】with extension and air purge system

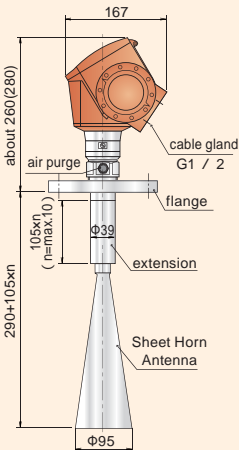

### VG6 0Y0

【DN 2 0 0】with air purge system

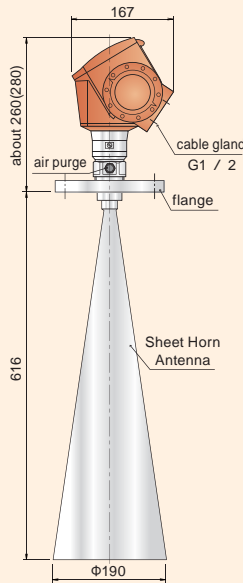

### VG6 0Y 1~B

【DN 2 0 0】with extension and air purge system

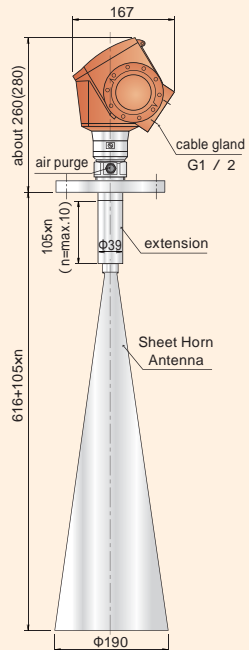

Antenna	SUS316L
Beam angle	5°(half angle)
Measuring range	30m(depends on application)
Dead band	0.3m from antenna top (depends on application)
Pressure	4.0MPa
Temperature	200 (Seal material :FKM)

Antenna	SUS316L
Beam angle	4°(half angle)
Measuring range	40m(depends on application)
Dead band	0.3m from antenna top (depends on application)
Pressure	4.0MPa
Temperature	200 (Seal material :FKM)

Antenna	SUS316L
Beam angle	4°(half angle)
Measuring range	40m(depends on application)
Dead band	0.3m from antenna top (depends on application)
Pressure	4.0MPa
Temperature	200 (Seal material :FKM)

Antenna	SUS316L
Beam angle	4°(half angle)
Measuring range	60m(depends on application)
Dead band	0.3m from antenna top (depends on application)
Pressure	4.0MPa
Temperature	200 (Seal material :FKM)

Antenna	SUS316L
Beam angle	4°(half angle)
Measuring range	60m(depends on application)
Dead band	0.3m from antenna top (depends on application)
Pressure	4.0MPa
Temperature	200 (Seal material :FKM)

### Antenna type selection graph (Powder)

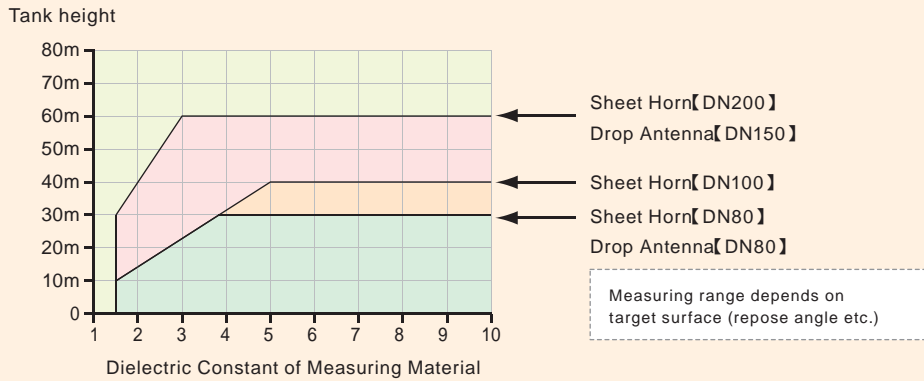

### Withstand Temperature and Pressure according to Combination of Antenna and Gasket

Antenna shape	Antenna model	Antenna material	Gasket material	Withstand temperature	Withstand pressure
Drop Antenna	DN80	PP	FKM / FPM	100	1.6 MPa
			Kalrez		
			EPDM		
	DN150	PTFE	FKM / FPM	100	4.0 MPa
			Kalrez		
			EPDM		
Sheet Horn Antenna	DN80	SUS316L	FKM / FPM	200	4.0 MPa
			Kalrez		
			EPDM		
	DN100	SUS316L	FKM / FPM	200	4.0 MPa
			Kalrez		
			EPDM		
DN200	SUS316L	FKM / FPM	200	4.0 MPa	
		Kalrez			
		EPDM			
Option					

### Model Select Table

VG6

#### Extension size

- 0. No extension (Note; Extension is provided for drop antenna.)
- 1. 105mm
- 2. 210mm
- 3. 315mm
- 4. 420mm
- 5. 525mm
- 6. 630mm Drop antenna unavailable
- 7. 735mm Drop antenna unavailable
- 8. 840mm Drop antenna unavailable
- A. 945mm Drop antenna unavailable
- B. 1050mm Drop antenna unavailable
- P. flange plate protection(PP) DN80/100 Drop Antenna available
- R. flange plate protection(PP) DN150 Drop Antenna available
- S. flange plate protection(PTFE)DN80/100 Drop Antenna available

#### Antenna type

- P. Drop DN80(PTFE) 75 mm
- S. Drop DN80(PP) 75 mm
- T. Drop DN150(PP) 144 mm
- V. Sheet Horn DN80 75 mm With air purge system
- X. Sheet Horn DN150 144 mm With air purge system
- Y. Sheet Horn DN200 190 mm With air purge system

#### Mounting · Antenna material

- 0. SUS316

#### Explosion proof

- 0. Non explosion proof
- 2. ATEX G/D 1 1/2 EEx ia C T6
- 3. ATEX G/D 1/2 2 EExd ia C T6

### Standard Specification

CaseMaterial	AL
Enclosure	IP66
Max.MeasuringRange	60m (depends on antenna and application)
PowerSupply	DC24V(DC14~30V)
	Refer to connection diagram when using meter relay and explosion proof type.
Blankingdistance	0.3m from antenna top
ContinuousOutput	DC4~20mA HART(Max.load resistance 350Ω)
ErrorOutput	DC3.6mA or DC22mA Selectable
Resolution	1mm
Repeatability	±5mm
Measurement Accuracy	less than 10m:±10mm On or over 10m:±0.1%
Withstand Temperature	-20 ~+80 (Explosion proof:-40~+60 )

\*Refer to each drawing for withstand pressure inside tank, withstand temperature and beam angle.

# FMCW-VG7

FMCW ▶ Frequency Modulated Continuous Wave

Liquid and Slurry Measurement

## Corrosive Liquid Measurable by Drop Antennawith Flange-Plate-Protection

Drop Antenna +  
Flange Plate  
Protection Model



Wetted part completely covered with resin, corrosion resistance, in medical liquid tank, is realized. PP or PTFE selectable for cover material.

### Drop Antenna Series

#### VG7 0 P/S P/S

[ DN 80 ]with flange plate protection

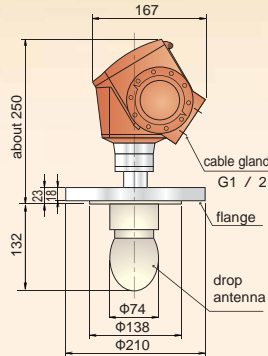

### Horn Antenna Series

#### VG7 050

[ DN50 ]

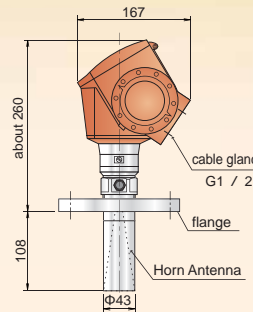

#### VG7 05 1~B

[ DN50 ]with extension

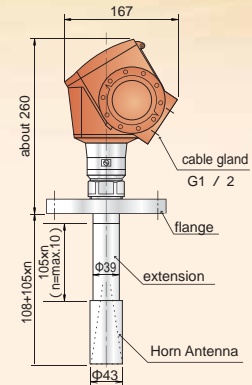

Antenna	PP / PTFE
Beam angle	4°(half angle)
Measuring range	8.0 m(depends on application)
Dead band	0.1m from antenna top (depends on application)
Pressure	P P : 1.6 MPa P T F E : 4.0 MPa
Temperature	P P : 100 (Seal material : FKM) P T F E : 150 (Seal material : FKM)

Antenna	SUS316L
Beam angle	7.5°(half angle)
Measuring range	2.0 m(depends on application)
Dead band	0.1m from antenna top (depends on application)
Pressure	4.0 MPa
Temperature	200 (Seal material : FKM)

Antenna	SUS316L
Beam angle	7.5°(half angle)
Measuring range	2.0 m(depends on application)
Dead band	0.1m from antenna top (depends on application)
Pressure	4.0 MPa
Temperature	200 (Seal material : FKM)

### Sheet Horn Antenna Series

#### VG7 0U0

[ DN80 ]

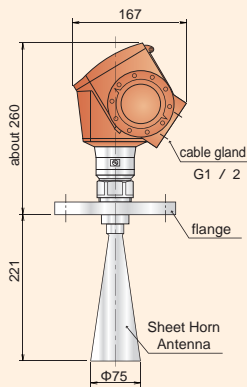

#### VG7 0U 1~B

[ DN 80 ]with extension

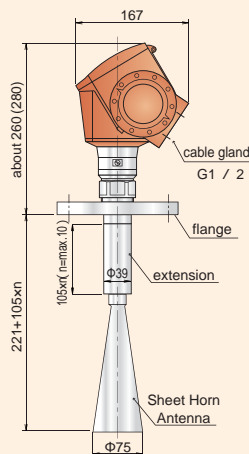

#### VG7 0V0

[ DN100 ]

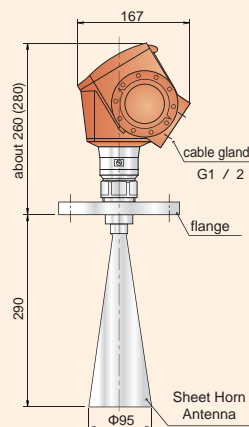

#### VG7 0V 1~B

[ DN100 ]with extension

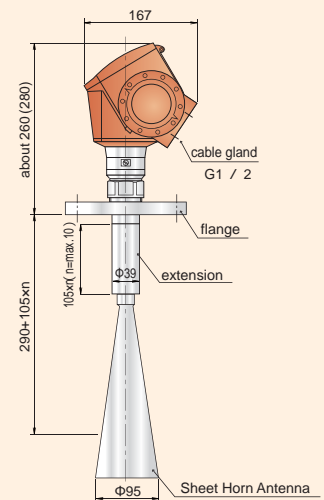

Antenna	SUS316L
Beam angle	5°(half angle)
Measuring range	8.0 m(depends on application)
Dead band	0.1m from antenna top (depends on application)
Pressure	4.0 MPa
Temperature	200 (Seal material : FKM)

Antenna	SUS316L
Beam angle	5°(half angle)
Measuring range	8.0 m(depends on application)
Dead band	0.1m from antenna top (depends on application)
Pressure	4.0 MPa
Temperature	200 (Seal material : FKM)

Antenna	SUS316L
Beam angle	4°(half angle)
Measuring range	8.0 m(depends on application)
Dead band	0.1m from antenna top (depends on application)
Pressure	4.0 MPa
Temperature	200 (Seal material : FKM)

Antenna	SUS316L
Beam angle	4°(half angle)
Measuring range	8.0 m(depends on application)
Dead band	0.1m from antenna top (depends on application)
Pressure	4.0 MPa
Temperature	200 (Seal material : FKM)

## Antenna Model Selection Graph (Liquid Measurement)

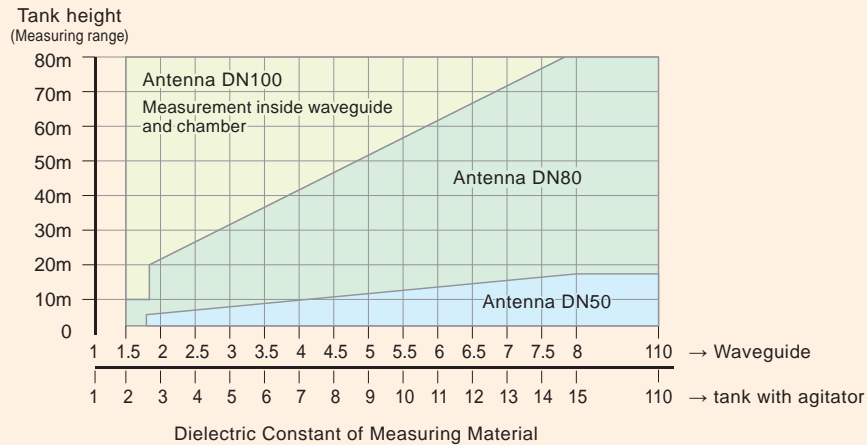

## Withstand Temperature and Pressure according to Combination of Antenna and Gasket

Antenna shape	Antenna model	Antenna material	Gasket material	Withstand temperature	Withstand pressure
Drop Antenna	DN80	PP	FKM / FPM	100	1.6 MPa
			Kalrez		
			EPDM		
Drop Antenna	DN80	PTFE	FKM / FPM	150	4.0 MPa
			Kalrez		
			EPDM		
Horn Antenna	DN80	SUS316L	FKM / FPM	200	4.0 MPa
			Kalrez	150	
			EPDM		
Sheet Horn Antenna	DN80	SUS316L	FKM / FPM	200	4.0 MPa
			Kalrez	150	
			EPDM		
	DN100	SUS316L	FKM / FPM	200	4.0 MPa
			Kalrez	150	
			EPDM		
					Option

## Model Select Table

VG7

— **Extension size**

0. No extension
1. 105mm
2. 210mm
3. 315mm
4. 420mm
5. 525mm
6. 630mm
7. 735mm
8. 840mm
- A. 945mm
- B. 1050mm
- P. Flange Plate Protection (PP)      DN80 Drop antenna available
- S. Flange Plate Protection (PTFE)      DN80 Drop antenna available

— **Antenna type**

5. Horn	DN50	43mm	
P. Drop	DN80(PTFE)	75mm	Only with Flange Plate
S. Drop	DN80(PP)	75mm	Only with Flange Plate
U. Sheet Horn	DN80	75mm	
V. Sheet Horn	DN100	95mm	

— **Mounting · Antenna material**

0. SUS316
1. Hastelloy C

— **Explosion proof**

0. Non explosion proof
2. ATEX G/D 1 1/2      EEx ia C T6      EEx ia C T6
3. ATEX G/D 1/2 2      EExd ia C T6      EExd ia C T6

## Standard Specification

Case Material	AL
Enclosure	IP66
Max.Measuring Range	80m(depends on antenna and application)
Power Supply	DC24V(DC14~30V)
	Refer to connection diagram when using meter relay and explosion proof type.
Blanking distance	0.1m from antenna top
Continuous Output	DC4~20mA HART
Error Output	DC3.6mA or DC22mA Selectable
Resolution	1mm
Repeatability	±3mm
Measurement Accuracy	0.05%
Withstand Temperature	-20 ~ +80 ( Explosion proof : -40 ~ +60 )

Refer to each drawing for withstand pressure inside tank, withstand temperature and beam angle.

# FMCW-VG5

FMCW ▶ Frequency Modulated Continuous Wave

Liquid and Slurry Measurement

**Low cost model!!**

**Double seal type wave horn antenna released**

### Feature

- Applicable to liquid, slurry, paste
- Max. Measuring range 30m
- Original wave horn antenna (PP/PTFE) with high seal quality
- Controller separate type available for improved operability (Option)
- 2 wire loop type

### Specification

Case material	AL(Option)
Enclosure	IP66
Power Supply	DC12 ~ 24V(2 wire loop : DC4 ~ 20mA)
Blanking Distance	0.1m from antenna top
Resolution	1mm
Withstand Temperature	-40 ~ +80

### Antenna

Sheet Horn Antenna 【DN150 DN200】	Material : SUS316L Temperature : 250 Mounting : Flange3'
PP Wave Horn Antenna	Material : PP Temperature : 100 Mounting : G1 · 1/2B screw
PTFE Wave Horn Antenna	Material : PTFE Temperature 150 Mounting : Flange2'

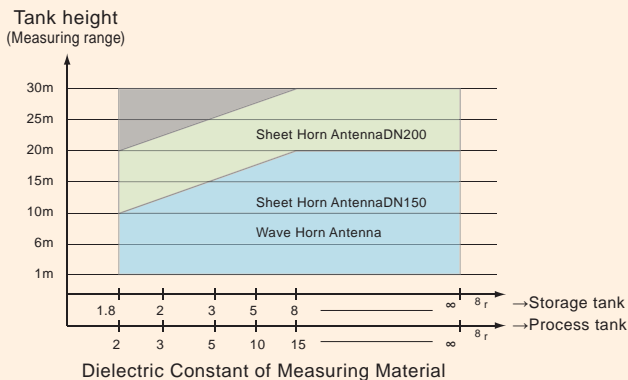

Sheet Horn Antenna

PP Wave Horn Antenna



Display Top

Display location selectable between side or top.

### Controller Separate Type (Option)

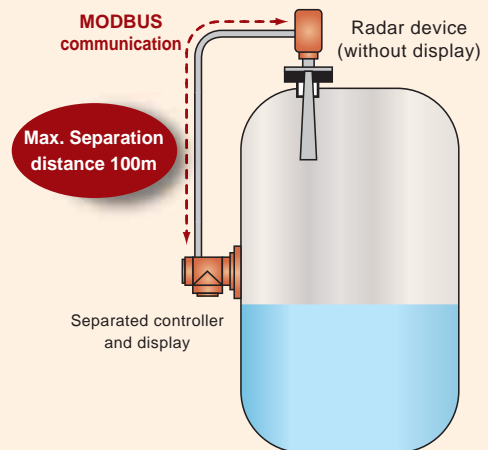

### Line of business

- Rotary Paddle Type Level Switch
- Vibration Type Level Switch
- Swing Type Level Switch
- Acoustic Level Switch
- Capacitance Type Level Switch
- Capacitive Proximity Sensor
- Capacitance Type Level Indicator
- Diaphragm Type Level Switch
- Tilt Switch
- Leak Type Level Switch
- Microwave Switch
- Sounding Bob Type Level Indicator
- Flow Switch
- Conductance Type Level Switch
- Float Switch
- Float Type Level Indicator
- Ultrasonic Type Level Indicator
- Equipments For Conveyor Lines
- Dust Monitor System
- Zirconia Oxygen Analyzer
- Laser Type Level Indicator
- RADAR Type Level Indicator
- On-line Sensors for Accurate Liquid Analysis
- Ultrasonic Flow meter

All-round Manufacturer of Level Controllers for Powder, Granules and Liquid

## KANSAI Automation Co.,Ltd.

Headquarters :  
2-14, Togano-cho, Kita-ku, Osaka 530-0056, Japan  
TEL. 81-6-6312-2071 FAX. 81-6-6314-0848  
e-mail: info@kansai-automation.co.jp

<http://www.kansai-automation.co.jp>



Tokyo Branch : 1-29-6, Hamamatsu-cho, Minato-ku, Tokyo 105-0013, Japan  
TEL. 81-3-5777-6931 FAX. 81-3-5777-6933

Nagoya Office : 3-31-27, Uchiyama, Chigusa-ku, Nagoya 464-0075, Japan  
TEL. 81-52-741-2432 FAX. 81-52-741-1588

Kyushu Office : 1-2-39, Asano, Kokura Kita-ku, Kitakyushu 802-0001, Japan  
TEL. 81-93-511-4741 FAX. 81-93-511-4580

Agent

\*Please be sure to read USER'S GUIDE, Installation & Operation Instructions before using the instrument.

\*The specifications herein may be subject to change without advance notice.