

Operating Instruction

Correct Use

The SCB is a universally applicable safety time control device, with which the moving parts of a machine or plant can be brought to a standstill quickly and safely in case of danger. Depending upon the configuration, the safety outputs connect on -delay, off-delay or without delay independent of one another.

The SCB has been conceptualised specially for use in machines and plants as well as in furnaces for continuous operation and is certified in accordance with EN 50156-1 and EN 746-2.

Features

- Depending on variant:
 - 2 safety semiconductor outputs / 2 safety relay contacts
 - 2 safety contacts
 - 3 safety semiconductor outputs
- Switching behaviour configurable on the device
- 2 semiconductor auxiliary outputs
- Adjustable switch-on / switch-off delay:
 - Depending on variant: 0 to 99 s; 0 to 99 min; 0 to 99 h
- Connection of:
 - Emergency stop buttons
 - Safety switches
 - Non-contact safety switches
 - OSSD outputs

English translation



- Single or dual-channel operation possible
- Simple, fast and accurate (resolution $\geq 0,1$ Sec.) time adjustment via push/rotary button and display
- Indication of all switching states via LED
- Automatic or monitored, manual start
- Certified up to Cat. 4, PL e, SILCL 3 (also for delayed outputs) according to EN ISO 13849-1 / EN 62061 / EN 61508 / EN 61511 / EN 50156-1 / EN 746-2

Function

The safety time control device SCB is conceptualised for the safe isolation of safety circuits according to EN 60204-1 and can be used up to the safety category 4, PL e, SIL 3 according to EN ISO 13849-1 and EN 62061 as well as on furnaces in continuous operation according to EN 50156-1 and EN 746-2.

Depending upon the application, the outputs connect either in combination with a start button or in the Auto Start mode with or without delay, as soon as the safety circuit closes.

When a safety requirement prevails, the non-delayed safety contacts are switched off immediately and the delayed safety contacts are switched at the end of the parametrized delay time. It is ensured that one individual failure does not lead to loss of the safety function and that every fault is detected through cyclic self-monitoring latest during the next switch off and on again.

The auxiliary output C1 serves as immediate contact and switches off in the event of a safety requirement without delay. It thus signals an upcoming, time-delayed switching of the safety outputs.

switches on when the device detects a fault. The set delay time can be read from the display and can be adjusted in the range of 0.0 to 99 seconds, minutes or hours (depending on the variant) by using a push/rotary button.

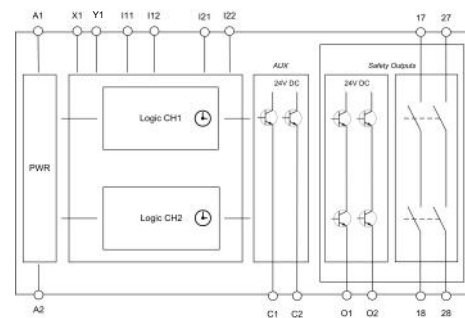

Fig. 1 Block diagram SCB

The auxiliary output C2 serves as fault signalling and

Installation

The device is designed according to EN 60204-1 for installation in control cabinets with the IP54 minimum protection class. The assembly is done on 35 mm mounting rail as per DIN EN 60715 TH35 with a distance of 10 mm from other devices. Ensure that there is sufficient heat dissipation in the control cabinet.

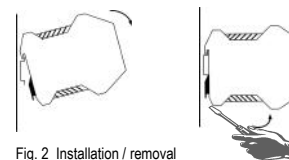

Fig. 2 Installation / removal

Safety Precautions



- The installation and commissioning of the device must be done **only by authorized qualified personnel**, who have read and understood the user information.
- Observe the national guidelines at the time of commissioning of the device.
- The electrical connection of the device must take place only when the voltage supply is switched off!
- The wiring of the device must be according to the instructions of this user information, otherwise there is a risk that the safety function will be lost.
- Opening and tampering with the device and by-passing the safety equipment is not permitted.
- Observe all the relevant safety guidelines and standards.

- The current paths 17-18 and 27-28 must carry only the same voltage potentials.
- The overall concept of the control, in which the device is integrated, must be validated by the user.
- Non-observance of the safety guidelines may lead to death, severe injuries and serious material damage.
- The device version (see nameplate "Ver.") should be stored and checked before every commissioning. When there is a version change, the use of the device in the overall application should be reevaluated.

Electrical Connection

- A safety transformer according to EN 61558-2-6 or a power supply unit with galvanic isolation should be connected upstream of the mains.
- External fuse should be provided for the relay safety contacts (6 A gG).
- Maximum cable length of 1000 m at a cable cross-section of 0.75 mm² for the control cables must not be exceeded.
- The cable cross section must not exceed 2.5 mm².
- If the device is not functional after commissioning, it must be returned unopened to the manufacturer. Once the device is opened, the warranty becomes void.



A1:	Power supply (24 V DC)
A2:	Power supply (0V)
I11/I21:	Safety circuit channel 1
I12/I22:	Safety circuit channel 2
X1:	Auto start or manual start
Y1:	Feedback circuit
17-18 / 27-28:	Safety relay contacts
C1:	Auxiliary output 1 (immediate - output)
C2:	Auxiliary output 2 (fault - output)
O1/O2:	Safety semiconductor outputs

Fig. 3 Connection - explanation (for the SCB-04)

Operating Instruction

English translation

Wiring

Depending on application or result of the risk assessment, e.g. according to EN ISO 13849-1, the device should be wired according to Fig. 1 to Fig. 10.

Starting Behaviour

INFO:

The starting behaviour is determined by the respective configuration (see section - configuration display - page 6).

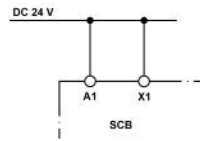

Fig. 1:
Automatic start.
Caution:
Safety contacts switch on immediately in the operating state.

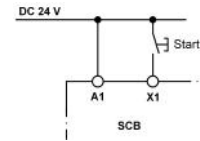

Fig. 2:
Monitored manual start.
The start release is triggered by a falling edge at X1, with which a complete switching operation of the start button is monitored

Feedback Circuit

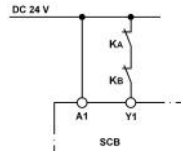

Fig. 3:
Feedback circuit.
Monitoring of externally connected contactors or expansion modules.

Note:
If the feedback circuit is not used, the contact Y1 should be wired to DC 24 V.

Emergency Stop Circuit

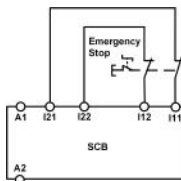

Fig. 4:
Dual-channel emergency stop circuit with cross circuit and earth contact monitoring.
(category 4, up to PL e / SIL 3)

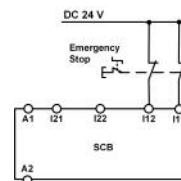

Fig. 5:
Dual-channel emergency stop circuit with earth contact monitoring.
(category 3, up to PL d / SIL 2)

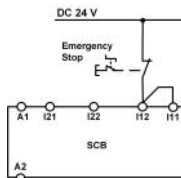

Fig. 6:
Single-channel emergency stop circuit with earth contact monitoring.
(category 1, up to PL c / SIL 1)

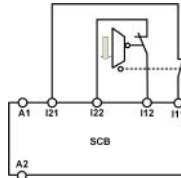

Fig. 7:
Dual-channel sliding guard monitoring with cross circuit and earth contact monitoring.
(category 4, up to PL e / SIL 3)

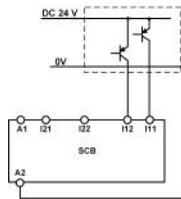

Fig. 8:
Dual-channel emergency stop circuit with PNP semiconductor outputs / OSSD outputs with seilerate cross circuit detection.
(category 4, up to PL e / SIL 3)

Power Supply and Safety Contacts

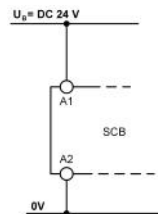

Fig. 9:
Connection of the power supply to the terminals A1 and A2 (power supply according to the tech. data)

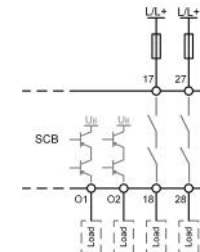

Fig. 10:
Connection to switching loads at safety contacts (Exemplary contact configuration. Differing according to device type. Switching voltage "L/L+" according to tech. data).

When switching inductive loads, HL outputs should be additionally provided with adequate protective circuitry.

Commissioning Procedure

Note: While commissioning, the points listed under "Electrical connection" are to be considered.

During initial commissioning, the delay time is 0 s so that all contacts switch immediately.

Caution: Wiring may only be carried out when the voltage supply is switched off.

1. Wire the start circuit:

Wire the start circuit according to Fig. 1 or Fig. 2 taking the configured start function into consideration (see section - configuration display - page 6).

Caution:

When "automatic start" is set, it should be ensured that the safety contacts switch immediately in operating mode. When "monitored manual start" is set, the start button should be opened after the wiring.

2. Wire the feedback circuit:

In case your application provides for external contactors or expansion modules, connect them to the device according to Fig. 3.

3. Wire the emergency stop circuit:

Wire the emergency stop circuit according to your application (see Fig. 4 to 8).

4. Wire the power supply:

Connect the power supply to the terminals A1 and A2 (see Fig. 9).

5. Start the device:

Switch on the operating voltage.

Caution:

If "automatic start" is set as the starting behaviour, close the safety contacts in the operating mode, taking into consideration the set configuration. If "monitored manual start" is set as the starting behaviour, actuate the start button to close the safety contacts.

6. Trigger the safety function:

Open the emergency stop circuit by actuating the attached safety switch. The safety contacts open according to their set configuration.

7. Switch on again:

Close the emergency stop circuit. If "automatic start" is selected, close the safety contacts taking into consideration the set configuration. If "monitored manual start" is set as the starting behaviour, actuate the start button to close the safety contacts.

Operating Instruction

English translation

Functions of the SCB

The SCB is controlled via a push/rotary button in combination with a display. Each of the setting and operation options as well as the functions of the SCB are explained in the following.

Operating State with Off-Delay Contacts

In the operating state, the current status of the SCB is shown on the display and the LEDs.

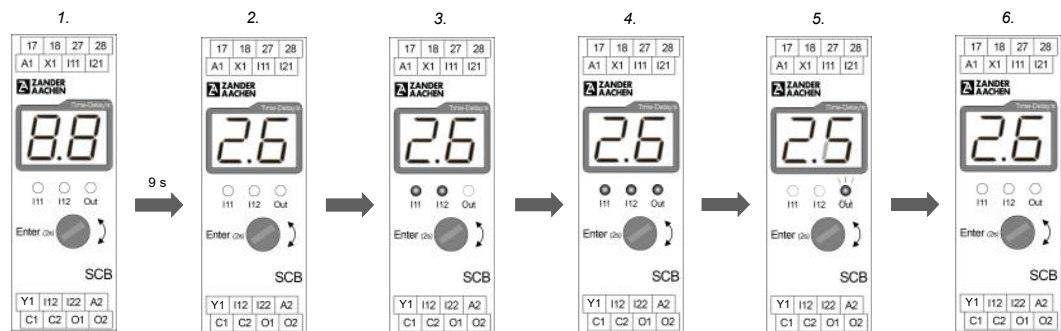

1. Power-On

After the supply voltage is applied, the SCB carries out a self-test (duration approx. 9 seconds). At the same time, each individual segment is controlled on the display, whereby the display can be checked for possible errors.

TIP: Checking the display before re-parametrising avoids possible incorrect settings due to display errors.

2. to 4. Operating state

In the operating state, the display shows the delay time currently stored in the SCB. The three LEDs *I11*, *I12* and *Out* provide information about the current status of the inputs and outputs.

INFO:

Picture 2: Current delay time is 2.6 s. Inputs and outputs are not activated.

Picture 3: Inputs *I11*/*I12* are activated, outputs are not activated.

Picture 4: Inputs *I11*/*I12* and outputs are activated.

5. Requesting the safety function

Through the opening of the safety circuit, the non-delayed outputs are immediately switched and the parametrized

delay time is started. The blinking *Out* LED as well as the countdown shown on the display provide information on the running delay time.

INFO:

The countdown is used only for monitoring. Deviations from the actual delay time can occur especially in long delay times (available only for types 472460, 472480, 472490).

6. Safe state

At the end of the delay time, the delayed outputs switch off and the currently saved delay time is again shown on the display.

Status LED	Description of the status
	<i>I11</i> / <i>I12</i> : Low at input. <i>Out</i> : Safety outputs not switched.
	<i>I11</i> / <i>I12</i> : High at input. <i>Out</i> : Safety outputs not switched.
	<i>Out</i> : Time-delay of outputs is running.

Note: For all variantes and operating states

Operating State with On-Delay Contacts

In the operating state, the current status of the SCB is shown on the display and the LEDs.

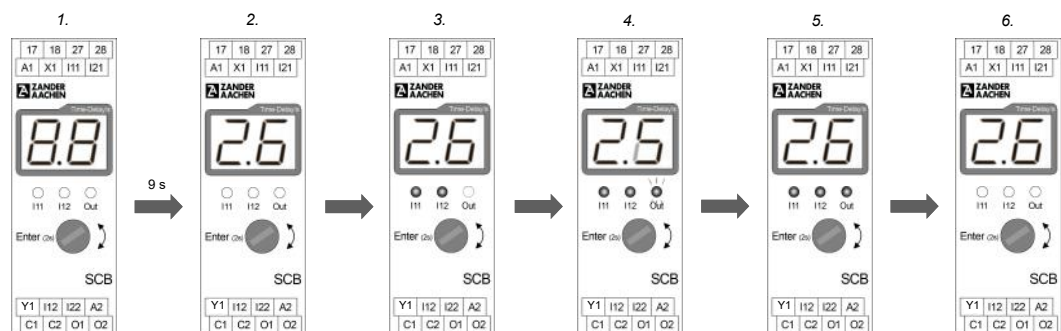

1. Power-On

After the supply voltage is applied, the SCB carries out a self-test (duration approx. 9 seconds). At the same time, each individual segment is controlled on the display, whereby the display can be checked for possible errors.

TIP: Checking the display before re-parametrising avoids possible incorrect settings due to display errors.

2. Operating state

In the operating state, the display shows the delay time currently stored in the SCB. The three LEDs *I11*, *I12* and *Out* provide information about the current status of the inputs and outputs.

3. to 4. Closing of the safety circuit

Through the closing of the safety circuit in combination with a start, the non-delayed outputs are immediately switched on. The blinking *Out* LED as well as the countdown shown on the display provide information on the running delay time of the delayed outputs (depends on the variant).

INFO:

The countdown is used only for monitoring. Deviations from the actual delay time can occur especially in long delay times (available only for types 472460, 472480, 472490).

5. Outputs switched

At the end of the delay time, the delayed outputs switch on and the delay time currently saved is again shown on the display.

6. Safe state

Through the opening of the safety circuit the outputs switch off immediately and the delay time currently saved is shown on the display.

Operating Instruction

English translation

Parametrization

The parametrization of the delay time is secured against unauthorised adjustment by a PIN. After successful entry of the PIN, the delay time can be set using the push/rotary button and the display in the range of 0.1 to 99 s/min/h with a resolution of ≥ 0.1 s/min/h.

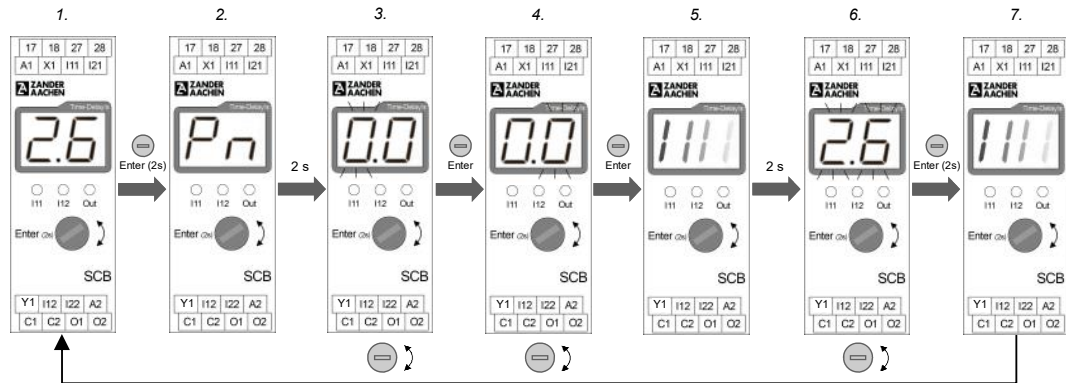

1. Operating state

The parametrise menu is entered by pressing the push/rotary button for 2 s.

INFO: PIN request can be entered only in safe state. Open the emergency stop circuit and wait until all safety outputs have switched off.

2. to 4. PIN entry

The access to PIN Entry is signalled by the indication *Pn*. The first digit of the PIN is shown as blinking. The first digit of the PIN is set by turning the push/rotary button. The first PIN digit is saved by pressing the button briefly and the second PIN digit can be set in the same way as the first one. The PIN Entry is ended by pressing the button briefly.

INFO: The PIN of the SCB is: **4 - 2**

In case of wrong PIN entry, an error indication *Er 18* appears. The error should be acknowledged by pressing the button for 2 s.

ATTENTION: After acknowledgement, the SCB goes back into the operating mode. If the starting behaviour "automatic start" is selected and the safety circuit is closed, the safety contacts close immediately.

After successful PIN entry, the delay time can be set by turning the push/rotary button. The delay time is confirmed and saved by pressing the button for 2 s.

TIP: To abort the parametrising, disconnect the supply voltage of the device.

7. System restart

The SCB applies the delay time.

ATTENTION: The supply voltage of the SCB must not be disconnected in this state. If the starting behaviour "Automatic start" is selected and the safety circuit is closed, the safety contacts close immediately.

6. Parametrizing the delay time

Symbol	Description
	Press the push/rotary button for minimum 2 seconds.
	Press push/rotary button briefly
	Turn push/rotary button
2 s	Wait for 2 seconds

Error Monitoring

The SCB detects errors and shows them with an error number in the display (see figure below). Some errors cannot be displayed. These are detected by unexpected or missing device reaction.

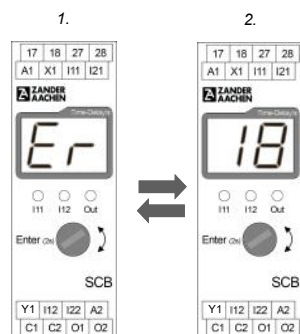

1. to 2. Fault display

The SCB signals the detected faults on the integrated display. For this, the *Er* and the respective fault number is displayed in an alternating manner.

No.	Cause	Solution / Acknowledgement
Er01	Input pair I11-I21 / I12-I22: Difference time is exceeded or single channel is switched off and switched-on again	<ul style="list-style-type: none"> Check wiring Check the function of the connected sensor Acknowledgement by opening and closing the safety circuit within the difference time (3 s)
Er11	Hung start button. Input X1 (if manual, monitored start is configured)	<ul style="list-style-type: none"> Check wiring Check the function of the start button Acknowledgement by switching off and again switching on the start button
Er17	PUK Incorrect	<ul style="list-style-type: none"> Acknowledgement by pressing the button for 2 seconds
Er18	PIN Incorrect	<ul style="list-style-type: none"> Acknowledgement by pressing the button for 2 seconds
Er49	Waiting state for the transition into an error mode (e.g. on expiry of a configured delay time)	<ul style="list-style-type: none"> Wait for the original fault number
Er51	Fault on Input circuit channel 1	<ul style="list-style-type: none"> Check wiring for cross circuits and short circuits Check assignment: I21 → I11; I22 → I12
Er52	Fault on Input circuit channel 2	<ul style="list-style-type: none"> Acknowledgement by pressing the button
Er68	Fault on Safety output O1 (SCB-03 / SCB-04) or internal error.	<ul style="list-style-type: none"> Check wiring for cross circuits and short circuits Check capacity on the output (see tech. data)
Er69	Fault on Safety output O2 (SCB-03 / SCB-04) or internal error.	<ul style="list-style-type: none"> If applicable, internal device error. Contact the Support of the manufacturer
Er70	Fault on Safety output O3 (SCB-03) or internal error.	<ul style="list-style-type: none"> If applicable, internal device error. Contact the Support of the manufacturer
Er91 bis Er99	Internal device fault	<ul style="list-style-type: none"> Check the safety outputs for cross circuits and short circuits and restart the device. If the problem continues: <ul style="list-style-type: none"> Reset the device to factory defaults If the problem continues: <ul style="list-style-type: none"> Contact the support of the manufacturer

Operating Instruction

Access to the PUK entry

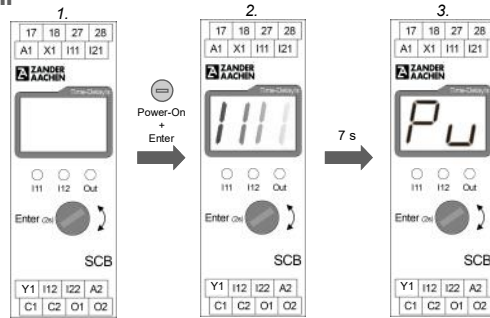

English translation

A reset of the current configuration or a new configuration for the SCB can be selected by entering a PUK (Parametrization Unlocking Key).

1. to 3. Access to the PUK

To go to the PUK Entry, switch on the supply voltage keeping the push/rotary button pressed.

Reset the Current Configuration

A reset of the current configuration can be performed by entering the PUK 7 - 6. The configured delay time is reset to 0.0 s/min/h. The configuration however remains unchanged.

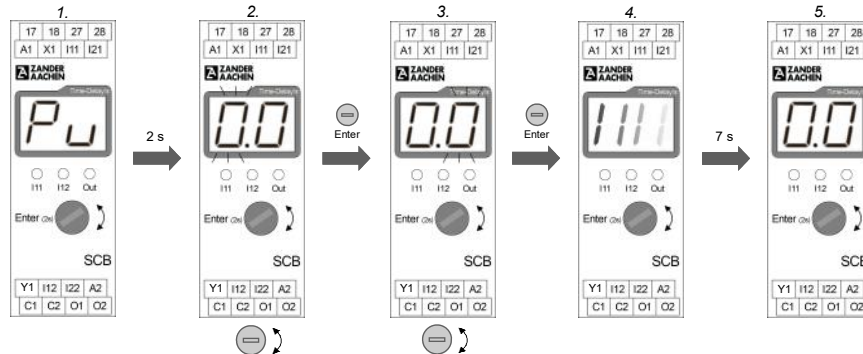

Note: For access to the PUK, see above.

1. to 3. PUK entry

The access to the PUK Entry is signalled by the indication *Pu*. The first digit of the PUK is shown as blinking. The first digit of the PUK is set by turning the push/rotary button. The first PUK digit is saved by pressing the button briefly and the second PUK digit can be set in the same way as the first one. The PUK Entry is ended by pressing the button briefly. To carry out a reset of the current configuration on the SCB, enter the following PUK: **7 - 6**

In case of wrong PUK entry, an error indication *Er 17* appears. The error should be acknowledged by pressing the button for 2 s.

After acknowledgement, it will go back to step 1. The entry

can be made again.

TIP:

To abort the PUK entry, disconnect the supply voltage of the device. On restart the SCB starts with the previously parametrized delay time.

4. to 5. Reset the current configuration

On successful entry of PUK, the reset of the current configuration is automatically carried out.

ATTENTION:

If the starting behaviour "Automatic start" is selected and the safety circuit is closed, the safety contacts are closed immediately after restart.

Setting a New Configuration

The configuration of SCB can be selected by entering the PUK **6 - 1**.

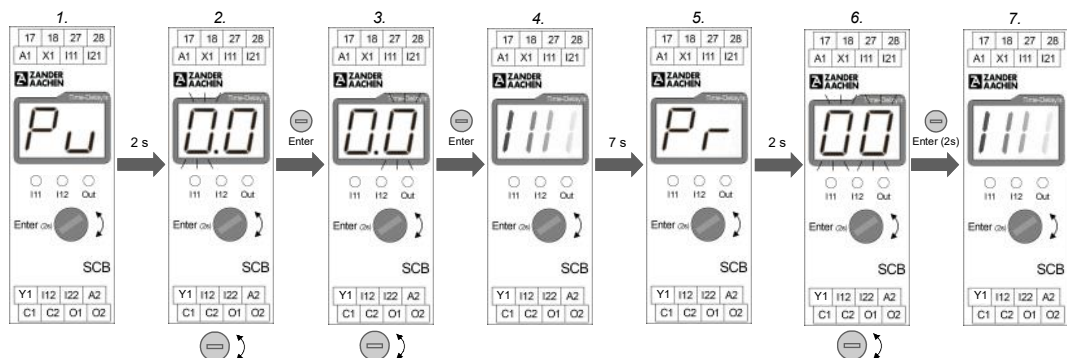

Note: For entering in the PUK, see above.

1. to 3. PUK entry

The access to the PUK entry is signalled by the indication *Pu*. The first digit of the PUK is shown as blinking. The first digit of the PUK is set by turning the push/rotary button. The first PUK digit is saved by pressing the button briefly and the second PUK digit can be set in the same way as the first one. The PUK Entry is ended by pressing the button briefly. To select the configuration of the SCB, enter the following PUK: **6 - 1**

In case of wrong PUK entry, an error indication *Er 17* appears. The error should be acknowledged by pressing the button for 2 s.

After acknowledgement, it will go back to step 1. The entry can be made again.

TIP:

To abort the PUK entry, disconnect the supply voltage of the device. On reset the SCB starts with the previously

parametrized delay time and configuration

4. to 7. Select and load configuration

After successful PUK entry, the access to the configuration selection is signalled by the indication *Pr*.

The desired configuration can now be loaded by turning the push/rotary button (see configuration table on page 6).

After selection of the desired configuration, it is confirmed by pressing the button for 2 seconds. The SCB loads the new configuration and restarts.

INFO:

A new configuration is always loaded with a preset delay time of 0.0 s/min/h.

ATTENTION:

If the starting behaviour "automatic start" is selected and the safety circuit closed, the safety contacts close immediately after restart.

Operating Instruction

English translation

Reset SCB to factory defaults

To reset SCB to factory defaults, follow the instructions on page 5 under the point "Setting a new configuration" and select the configuration 00.

Configuration Display

The information on the configuration currently loaded in the SCB can be read on the display by pressing the push/rotary button briefly.

Pr and the current configuration number are displayed in an alternating manner for 2 seconds.

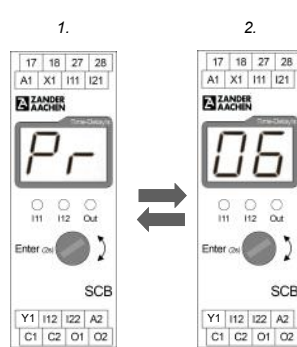

1. to 2. Configuration display

Display of the current configuration of the SCB on the integrated display. For this, Pr and the current configuration number are displayed in an alternating manner.

SCB-04 (all time variants): Configurations

Configuration no.		Non-delayed outputs				Delayed outputs				Delay type
Auto Start	Manual Start	O1	O2	17/18	27/28	O1	O2	17/18	27/28	
00	11	x	x	x	x					None
01	12		x	x	x	x				On-delay
02	13			x	x	x	x			
03	14	x	x					x	x	
04	15	x					x	x	x	
05	16					x	x	x	x	Off-delay
06	17		x	x	x	x				
07	18			x	x	x	x			
08	19	x	x					x	x	
09	20	x					x	x	x	
10	21					x	x	x	x	

SCB-03 (all time variants): Configurations

Configuration no.		Non-delayed outputs			Delayed outputs			Delay type
Auto Start	Manual Start	O1	O2	O3	O1	O2	O3	
00	07	x	x	x				None
01	08		x	x	x			On-delay
02	09			x	x	x		
03	10				x	x	x	
04	11		x	x	x			Off-delay
05	12			x	x	x		
06	13				x	x	x	

SCB-02 (all time variants): Configurations

Configuration no.		Non-delayed outputs		Delayed outputs		Delay type
Auto Start	Manual Start	17/18	27/28	17/18	27/28	
00	03	x	x			None
01	04			x	x	On-delay
02	05			x	x	Off-delay

Check and Maintenance

The following checks are regularly required to ensure proper and continuous functioning:

- Check the switch function
- Check for signs of manipulation and safety function bypassing
- Check if the device is mounted and connected securely
- Check for soiling

Check if the safety device is working properly, in particular:

- Every time after initial commissioning
- Every time after replacing a component
- After every fault in the safety circuit

Regardless of this, the safe functioning of the safety device should be checked at suitable intervals, e.g. as part of the maintenance schedule of the plant. No maintenance is required for the device itself

Operating Instruction

English translation

Safety Characteristic According to EN ISO 13849-1, EN 62061 / EN 61508

The device is certified according to EN ISO 13849-1 up to PL e in accordance with EN 62061 and / EN 61508 up to SILCL 3.

Note:

For applications that deviate from these framework conditions, additional information may be requested from the manufacturer.

Calculation of characteristic values for the relay outputs under the following assumptions:			
DC-13; DC 24 V			
Load per contact	-	≤ 1 A	≤ 2 A
T _M [Year]	-	20	20
n _{op} [Max. cycles per year]	-	≤ 100.000	≤ 10.000
AC-15; AC 250 V			
Load per contact	≤ 0.5 A	≤ 1 A	≤ 2 A
T _M [Year]	20	20	20
n _{op} [Max. cycles per year]	≤ 65.000	≤ 20.000	≤ 5.000

Application	Output/Contact	EN ISO 13849-1			EN 62061 / EN 61508		
		PL	Category	PFH [1/h]	SIL	PFD _{AVG}	PFH [1/h]
Single-channel emergency stop circuit (see page 2, Fig. 6)	Semiconductor	c	1	1.14E-06	1	1.22E-04	1.39E-09
	Relay	c	1	1.14E-06	1	7.78E-04	8.88E-09
Dual-channel emergency stop circuit without cross circuit monitoring (see page 2, Fig. 5)	Semiconductor	d	3	1.03E-07	2	2.26E-05	2.58E-10
	Relay	d	3	1.03E-07	2	3.65E-05	4.21E-10
Dual-channel emergency stop circuit with cross circuit monitoring (see page 2, Fig. 4, 7 and 8)	Semiconductor	e	4	7.04E-09	3	2.23E-05	2.55E-10
	Relay	e	4	2.47E-08	3	3.62E-05	4.18E-10

Safety Characteristic for Use in Furnaces in Continuous Operation According to EN 50156-1 / EN 746-2

Application	Output/Contact	EN 62061 / EN 61508					Note
		SIL	PFD _{avg}	PFH [1/h]	T _M [Year]	PTI [Year]	
Single-channel emergency stop circuit (see page 2, Fig. 6)	Semiconductor	1	1.22E-04	1.39E-09	20	20	For use in furnaces in continuous operation as per EN 50156-1 / EN 746-2
	Relay	1	1.65E-04	1.89E-09	20	20	
Dual-channel emergency stop circuit without cross circuit monitoring (see page 2, Fig. 5)	Semiconductor	2	2.26E-05	2.58E-10	20	20	
	Relay	2	2.35E-05	2.68E-10	20	20	
Dual-channel emergency stop circuit with cross circuit monitoring (see page 2, Fig. 4, 7 and 8)	Semiconductor	3	2.23E-05	2.55E-10	20	20	
	Relay	3	2.32E-05	2.65E-10	20	20	

Techn. Data

Electrical data	
Operating voltage	U _B : DC 24 V
Voltage tolerance	+ 10 % / - 15 %
Power consumption (no load) at U _B	3.6 W
Display	2-digit x 7-segment LED display; 3 LEDs
Power-on delay	9 s
Two-channel safety inputs	
Number	1
Input current at high level	Type 7 mA
Galvanic isolation	no
Low level	min: 0 V; max: 5 V
High level	min: 18 V; max: U _B
Max. Switch on delay	800 ms (+ configured delay times, if applicable)
Max. switching frequency	0,8 Hz
Start input/ feedback circuit	
Number	per 1
Function	X1:Auto start / monitored manual start (depending on configuration) Y1: Monitoring of external contactors or expansion modules
Input current at high level	Typ. 7 mA
Galvanic isolation	no
Low level	min: 0 V; max: 5 V
High level	min: 18 V; max: U _B

Safety semiconductor outputs	
Number	
SCB-02 (all variants)	0
SCB-03 (all variants)	3
SCB-04 (all variants)	2
Structure	PNP outputs, diverse
Switching capacity per output	$U_B / 500 \text{ mA}$
Max. capacity load	0.5 μF per 10 mA output current
Max. Pulse duration for selftest	< 3 ms
Galvanic isolation	no
Short-circuit-proof	yes
Max. switch-off delay	160 ms (+ configured delay times, if applicable)
Output voltage at "1" (max. load)	$U_B - 1 \text{ V}$
Safety relay outputs	
Number	
SCB-02 (all variants)	2
SCB-03 (all variants)	0
SCB-04 (all variants)	2
Switching capacity per contact (0,1 Hz)	AC: 250 V, 1000 VA, 4 A for resistive load DC: 50 V, 200 W, 4 A for resistive load AC-15: 2 A / AC 250 V; DC-13: 3 A / DC 24 V
Minimum contact load	10 V / 10 mA
Contact fuse	6 A gG Factor 0.6 for applications acc. to EN 50156-1 (See Chapter 10.5.5.3.4)
Contact material	AgNi; AgSnO2
Contact service life	mech. 1×10^7 switching cycles
Auxiliary outputs:	
Number	2
Structure	PNP outputs, single channel
Switching capacity per output	
SCB-02 (all variants)	C1: $U_B / 200 \text{ mA}$ C2: $U_B / 50 \text{ mA}$
SCB-03 (all variants)	C1: $U_B / 500 \text{ mA}$ C2: $U_B / 50 \text{ mA}$
SCB-04 (all variants)	C1: $U_B / 500 \text{ mA}$ C2: $U_B / 50 \text{ mA}$
Galvanic isolation	no
Short-circuit-proof	yes
Output voltage at „1“ (max. load)	$U_B - 1 \text{ V}$
Environmental data	
Ambient temperature	0 °C to +55 °C - see derating characteristic curves
Storage temperature	-20 °C to 85 °C
Humidity rating	93 % RH at +40 °C, non-condensing
Vibrations as per EN 60068-2-64 - Frequency	10 Hz to 150 Hz
Vibrations as per EN 60068-2-64 - Acceleration	0.5 g
EMC	EN 61326-3-1
Air and creepage distance	As per EN 60664-1
Overvoltage category	III (DIN VDE 0110-1)
Degree of soiling	2 (DIN VDE 0110-1)
Rated insulation voltage	50 V (For SELV/PELV circuit) 250 V (Between relay circuit and SELV/PELV circuit)
Rated surge voltage strength	800 V - Basic insulation for SELV/PELV circuit 6 kV - Safe insulation, reinforced insulation between relay circuit and SELV/PELV circuit
Mechanical data	
Degree of protection	IP20
Assembly	Mounting rail as per EN 60715TH35
Max. cable length	1000 m at 0.75 mm ²
Cable cross-section	0.25 - 2.5 mm ²
Dimensions (W x H x D)	22.5 x 99 x 118 mm
Weight	SCB-02/04: approx. 145 g; SCB-03: approx. 110 g (without packing)
Housing material	Polyamide PA6.6
Type of connection	Plug-in screw or tensile spring terminals

Derating

Total current limiting curve depends on ambient temperature
Heat-generating devices at 10 mm distance

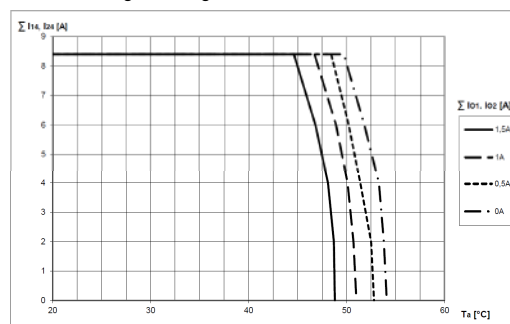

(10 mm minimum distance from the neighbouring devices)

Non heat-generating devices at 10 mm distance

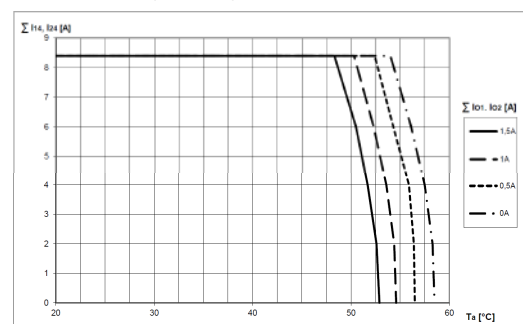

Operating Instruction

English translation

Dimensions

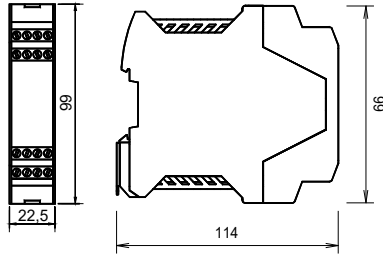

Variations

Variants incl. plug-in screw terminals

Order no. 474460	SCB-04, DC 24 V, 2 semiconductor contacts, 2 relay contacts 0 - 99 s	incl. plug-in screw terminals
Order no. 474480	SCB-03, DC 24 V, 3 semiconductor contacts, 0 relay contacts 0 - 99 s	incl. plug-in screw terminals
Order no. 474490	SCB-02, DC 24 V, 0 semiconductor contacts, 2 relay contacts 0 - 99 s	incl. plug-in screw terminals
Order no. 474461	SCB-04m, DC 24 V, 2 semiconductor contacts, 2 relay contacts 0 - 99 min	incl. plug-in screw terminals
Order no. 474481	SCB-03m, DC 24 V, 3 semiconductor contacts, 0 relay contacts 0 - 99 min	incl. plug-in screw terminals
Order no. 474491	SCB-02m, DC 24 V, 0 semiconductor contacts, 2 relay contacts 0 - 99 min	incl. plug-in screw terminals
Order no. 474462	SCB-04h, DC 24 V, 2 semiconductor contacts, 2 relay contacts 0 - 99 h	incl. plug-in screw terminals
Order no. 474482	SCB-03h, DC 24 V, 3 semiconductor contacts, 0 relay contacts 0 - 99 h	incl. plug-in screw terminals
Order no. 474492	SCB-02h, DC 24 V, 0 semiconductor contacts, 2 relay contacts 0 - 99 h	incl. plug-in screw terminals

Variants incl. plug-in spring-cage terminals

Order no. 475460	SCB-04, DC 24 V, 2 semiconductor contacts, 2 relay contacts 0 - 99 s	incl. plug-in spring-cage terminal
Order no. 475480	SCB-03, DC 24 V, 3 semiconductor contacts, 0 relay contacts 0 - 99 s	incl. plug-in spring-cage terminal
Order no. 475490	SCB-02, DC 24 V, 0 semiconductor contacts, 2 relay contacts 0 - 99 s	incl. plug-in spring-cage terminal
Order no. 475461	SCB-04m, DC 24 V, 2 semiconductor contacts, 2 relay contacts 0 - 99 min	incl. plug-in spring-cage terminal
Order no. 475481	SCB-03m, DC 24 V, 3 semiconductor contacts, 0 relay contacts 0 - 99 min	incl. plug-in spring-cage terminal
Order no. 475491	SCB-02m, DC 24 V, 0 semiconductor contacts, 2 relay contacts 0 - 99 min	incl. plug-in spring-cage terminal
Order no. 475462	SCB-04h, DC 24 V, 2 semiconductor contacts, 2 relay contacts 0 - 99 h	incl. plug-in spring-cage terminal
Order no. 475482	SCB-03h, DC 24 V, 3 semiconductor contacts, 0 relay contacts 0 - 99 h	incl. plug-in spring-cage terminal
Order no. 475492	SCB-02h, DC 24 V, 0 semiconductor contacts, 2 relay contacts 0 - 99 h	incl. plug-in spring-cage terminal

CE Konformitätserklärung
EC Declaration of Conformity
Déclaration de conformité



Hersteller: H. ZANDER GmbH & Co. KG
Producer: Am Gut Wolf 15 • 52070 Aachen • Deutschland
Fabricant:

Produktgruppe: Sicherheits-Not-Halt-System
Product Group: Safety emergency stop system
Groupe de produits: Système de sécurité d'arrêt d'urgence

Produkt Name Product Name Nom du produit	Anbringung der CE-Kennzeichnung Affixing of CE marking: Application du marquage CE	Zertifikats-Nr. No of Certificate N° du certificat
TB-11403	2016	01/205/5420 01/16
SCB-02	2016	01/205/5420 01/16
SCB-03	2016	01/205/5420 01/16
SCB-04	2016	01/205/5420 01/16

Die Produkte stimmen mit den Vorschriften folgender Europäischer Richtlinien überein:
The products conform with the essential protection requirements of the following European directives:
Les produits sont conformes aux dispositions des directives européennes suivantes:

2006/42/EG : Maschinenrichtlinie	2011/65/EU: RoHS Richtlinie
2006/42/EG : Machinery directive	2011/65/EU: RoHS directive
2006/42/EG : Directive Machines	2011/65/EU: Directive RoHS

2014/30/EU : EMV Richtlinie
2014/30/EU : EMC directive
2014/30/EU : Directive CEM

Die Übereinstimmung der bezeichneten Produkte mit den Vorschriften der o.a. Richtlinie wird, falls anwendbar, nachgewiesen durch die vollständige Einhaltung folgender Normen:
If applicable, the conformity of the designated products is proved by full compliance with the following standards:
Le strict respect des normes suivantes confirme, s'il y a lieu, que les produits désignés sont conformes aux dispositions de la directive susmentionnée:

EN 60439-1:2005-01	EN 60947-1:2011-10	EN 60947-5-1:2010-04
EN 61000-6-2:2006-03	EN 61000-6-3:2011-09	DIN EN 61326-3-1:2008-11

Gemäß Zertifikat der benannten Stelle:
According to the certificate of the below mentioned organisation:
Selon de organisme notifié:

EN 62061:2005 + AC:2010+A1:2013+A2:2015	DIN EN ISO 13849-1:2015
IEC 61508 Parts 1-7:2010	IEC 61511-1:2016

Benannte Stelle / Notified body / Organisme notifié:
Nr. NB 0035
TUV Rheinland Industrie Service GmbH
10882 Berlin
Zertifizierungsstelle für Maschinen

Dokumentationsbeauftragte/-r: Christiane Nitschak
Documentation manager
Autorisée à constituer le dossier technique:

Aachen, den 13.07.2017

Dipl.-Ing. Walter Zander
Geschäftsleitung
General Manager
Direction

Dipl.-Ing. Alfons Ausierhoff
Leiter CE-Konformitätsbewertung
Manager for EC declaration of conformity
Responsable évaluation de conformité CE

H. ZANDER GmbH & Co. KG • Am Gut Wolf 15 • 52070 Aachen • Germany
Tel +49 (0)241 9105010 • Fax +49 (0)241 91050138 • info@zander-aachen.de • www.zander-aachen.de