

EQUIPMENT FOR CONVEYOR LINES

Conveyor Peripherals

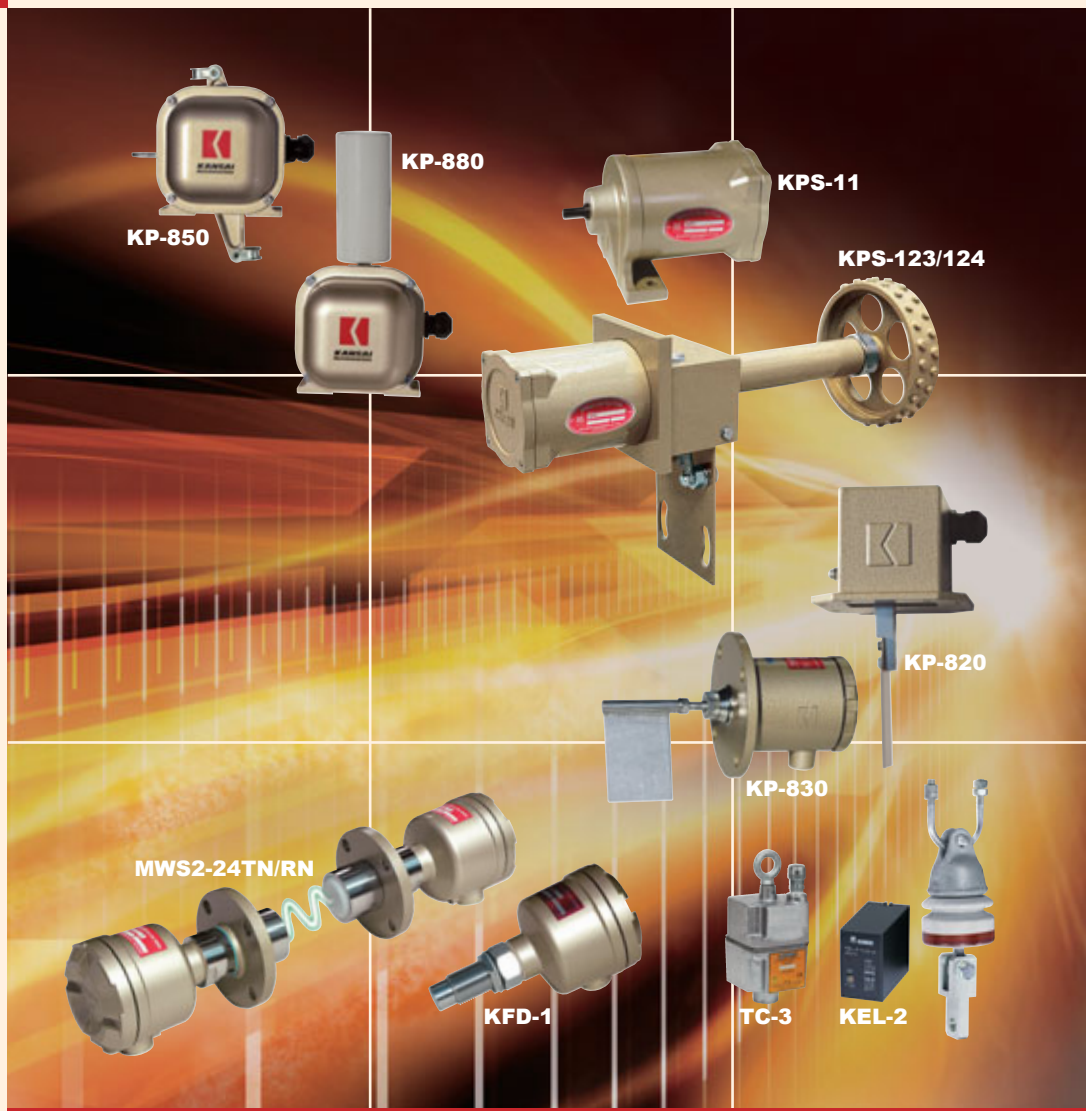

**Conveyor Peripherals KP Series;
Wide range of Products**

CONVEYOR PERIPHERALS SWITCH

Ensuring Safety of Conveyor Lines with Reliable Operation

Emergency Pull-wire Switch Two-Direction Operation and Manual Reversion (KP-850-1 · KP-860 · KP-870)

Here are the switches to have a belt-conveyor stop. These are the best for the emergency stop

- You can use it as a conveyor emergency-stop device because it is simply structured with the reliable operation. Tow-direction operating system
- It is of drip-proof structure, being IP67 (*KP-860, KP-870: equivalent to IP54)
- The pulling rope is 50m at the maximum. (Refer to the Mounting Instructions)



KP-850-1

(Standard)

Standard Specifications

- Action : Manual-reset
- Power Source : No need
- Output Contact : SPDT×1
- Contact Capacity : 250VAC 10A
- Contact Range : C – A are closed depending on the tilt of wire lever.
- Process Connection : 2 ×Φ10 Hole, Pitch 110
- Enclosure Rating : IP67

*Optionally available is KP-850-2 having 2 contacts and being used for both Alarm and control.



Wiring Diagram

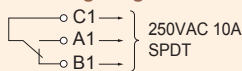

Outline Drawing

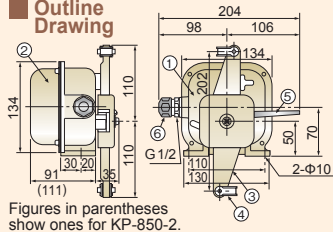

Figures in parentheses show ones for KP-850-2.

No.	Parts Name	Material
1	Housing	ADC
2	Cover	SPCC
3	Wire Lever	ADC
4	Wire Fastener	SPCE
5	Reversion Lever	BC
6	Cable Gland	Φ8-12indiameter

KP-860

(with Operating Display Light)

Standard Specifications

- Action : Manual-reset
 - Indication : Operation Lamp (Red)
 - Power Source : 100VAC or 200VAC
 - Output Contact : SPDT×2 *One For Indication Lamp
 - Contact Capacity : 250VAC 10A
 - Contact Range : Depending on the tilt of wire lever, C – A are closed, and Operating Lamp turns on (or turns off).
 - Process Connection : 2 ×Φ10 Hole, Pitch 110
 - Enclosure Rating : Equivalent to IP54
- *Specify the power voltage (DC can be available)

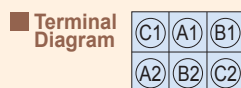

Wiring Diagram

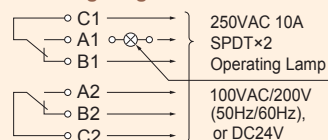

Outline Drawing

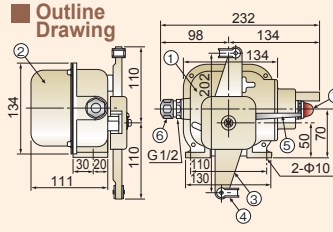

No.	Parts Name	Material
1	Housing	AC
2	Cover	SPCC
3	Wire Lever	ADC
4	Wire Fastener	SPCE
5	Reversion Lever	BC
6	Cable Gland	Φ8-12indiameter
7	Indication Lamp	Red

KP-870

(with Operating Display Board)

Standard Specifications

- Action : Manual-reset
- Indication : Indication Plate (Red)
- Power Source : No need
- Output Contact : SPDT×2
- Contact Capacity : 250VAC 10A
- Contact Range : C1 & A1 and C2 & A2 are closed depending on the tilt of wire lever.
- Process Connection : 2 ×Φ10 Hole, Pitch 110
- Enclosure Rating : Equivalent to IP54

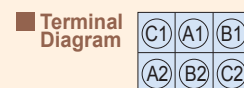

Wiring Diagram

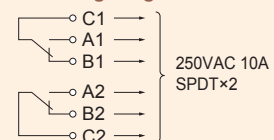

Outline Drawing

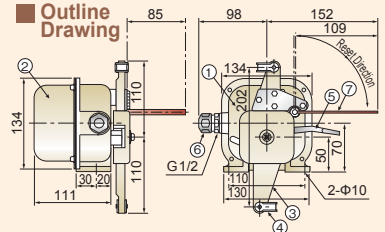

No.	Parts Name	Material
1	Housing	ADC
2	Cover	SPCC
3	Wire Lever	ADC
4	Wire Fastener	SPCE
5	Reversion Lever	BC
6	Cable Gland	Φ8-12indiameter
7	Indication board	SPCC (Red)

Conveyor-belt Alarm Switch

detecting the belt-moving-off-to-one-side

It can detect operational exceptions such as belt moving-off-to-one-side or meandering and protect the belt from break and prevent the conveyor line from any mechanical problem.

KP-880



Features

- The housing main body is of aluminum casting and of light/robust build.
- It is of drip-proof structure, being IP67.
- It is two-contact system to be used for both alarm and control. (250VAC 10A)

Contact operating angle

1. A2 – C2 are closed at the tilt angle of 20° (B2 – C2 opened)
2. A1 – C1 are closed at the tilt angle of 35° (B1 – C1 opened)
3. Respective contact reversion-angle is 2 – 3°
4. The above being a standard setting, you can change the operating angle

Terminal Diagram

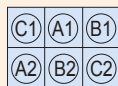

Rangs of Contact- point close

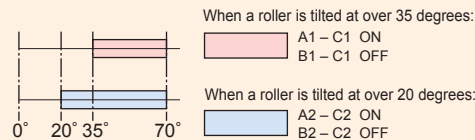

Outline Drawing

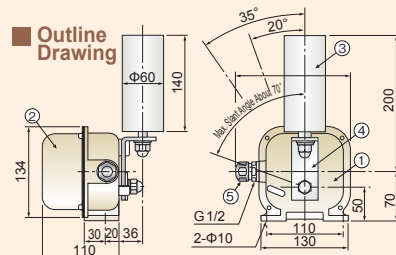

No.	Parts Name	Material
1	Housing	AC
2	Cover	SPCC
3	Roller	SGP
4	Roller lever	SS
5	Cable gland	Φ8 –12 in diameter

MOUNTING NOTES KP-850-1 · 860 · 870

- Use a rope, Φ3–6.5, of JISG3525. Actually a SUS304 rope, Φ4, is often used.
- Fix mounting holes (2×Φ10) on the switch horizontally to the mounting surface.
- When it comes to connecting a rope to the switch, put it on the wire clip to fix.
- A cab tyre cable of 1.25 – 2sq best fits.
- Because it is for an emergency purpose, the number of usage is extremely low. You should include the operation test into maintenance items to ensure a reliable operation in a possible emergency.

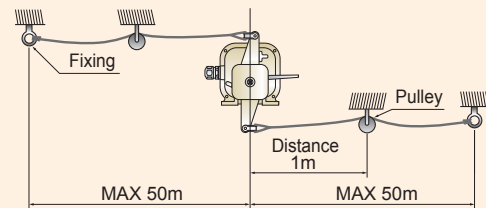
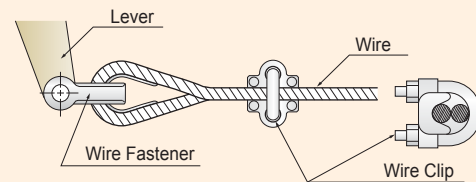

*Actuation Force (including wire tension and weight) is 4.8 kg.

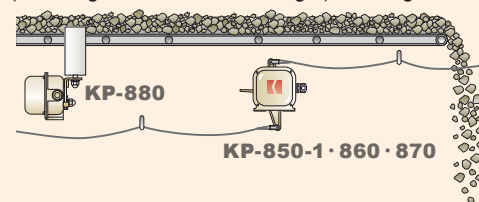

- Adjust the size of the mounting stand to that of conveyor.

Occupational Safety and Health Regulations Article 151-78

The official gazette dated December 27, 1977, rules stipulating that, from the standpoint of laborers safety, conveyors may be equipped with Emergency Stop Device such as Emergency Pull-wire Switch. An employer must provide with a device with which the employee can stop the operation of conveyors (called as Emergency Stop Device by Article 151-82) in a possible emergency case where laborers may be exposed to some danger including a part of their body caught in conveyors.

SPEED DETECTOR Reliably Catching Changes of Conveyor Speed ! Preventing Motor

Directly Connected to Shaft
Reliably Monitoring Rotating Speed

Non-contact Type, Easy to Handle,
Reliably Monitoring Rotating Speed

KPS-11
(Photo Sensor)



KPS-21
(Proximity Sensor)



■ Features

- It can detect to the high accuracy with a digital control system adopted.
- You can arbitrarily set up the operating speed in the range of 3~1999rpm. Accordingly it can widely be applied.
- The response is fast, and the time lag of output signal is about 5 seconds.
- The built-in startup compensation timer makes it possible to set up the startup compensation of about 99 seconds at the maximum.

■ Features

- It can detect to the high accuracy with a digital control system adopted.
- You can arbitrarily set up the operating speed in the range of 3 - 1999rpm. Accordingly it can widely be applied.
- Because a proximity sensor is used as a sensing element, it can certainly operate in the discretionary detecting-distance less than 8mm. Its operating life is longer because it, being non-contact, has no moving part.
- The built-in startup compensation timer makes it possible to set up the startup compensation of about 99 seconds at the maximum.

■ Standard Specification

Power Source : 105/210VAC ±10% 50/60Hz
 Power Consumption : 2.5VA
 Output Contact : SPDT
 Contact Capacity : 250VAC 5A 30VDC 5A
 Allowable Speed : below 2000rpm
 Setup Range : 3~1999rpm
 Measurement Error : 2rpm
 Start-up Compensation Timer : 0~99 seconds
 Instrument Allowable Temperature : -10°C~60°C(No condensation)
 Enclosure Rating : IP54 or equivalent
 Cable Gland : G3/4

■ Standard Specification

Power Source : 105/210VAC ±10% 50/60Hz
 Power Consumption : 2.5VA
 Output Contact : SPDT
 Contact Capacity : 250VAC 5A, 30VDC 5A
 Allowable Speed : below 2000rpm
 Setup Range : 3~1999rpm
 Measurement Error : 2rpm
 Start-up Compensation Timer : 0~99 seconds
 Instrument Allowable Temperature : -10°C~60°C(No condensation)
 Enclosure Rating : IP54 or equivalent
 Cable Gland : G3/4

■ Outline Drawing

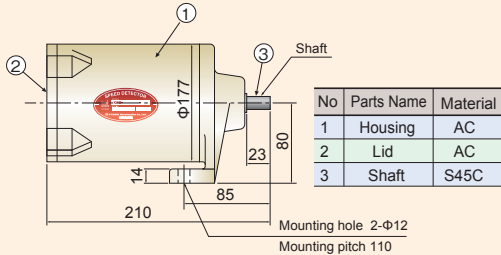

■ Outline Drawing

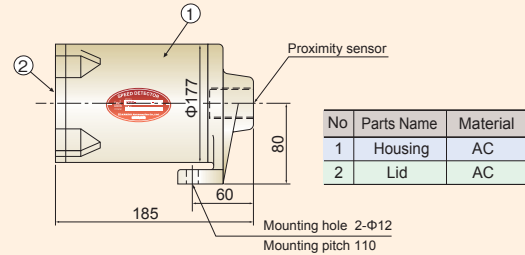

■ Mounting

KPS-11

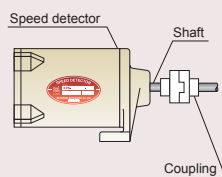

KPS-21

Mounting the device running parallel to the shaft

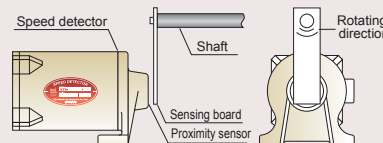

Mounted vertically to the shaft

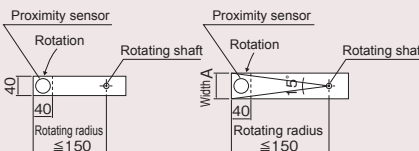
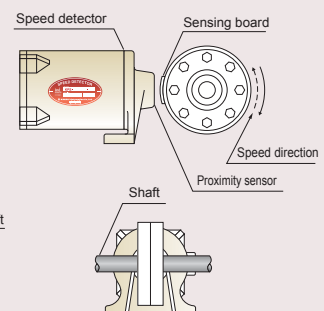

and other Components from being Damaged or Burnt out

Reliably catching Conveyor Performance via easy fixing



KPS-123/124
(Touch-roll Type)

■ Features

- It can detect to the high accuracy with a digital control system adopted.
- You can arbitrarily set up the operating speed in the range of 3~1999rpm. Accordingly it can widely be applied.
- The response is fast, and the time lag of output signal is about 5 seconds.
- The built-in startup compensation timer makes it possible to set up the startup compensation of about 99 seconds at the maximum.
- Detecting the belt speed in having the roller directly contact the belt, it can accurately catch the changes of its speed.

■ Standard Specification

Power Source : 105VAC/210VAC ±10% 50/60Hz
 Power Consumption : 2.5VA
 Output Contact : SPDT
 Contact Capacity : 250VAC 5A, 30VDC 5A
 Allowable Speed : below 2000rpm
 Setup Range : 3~1999rpm
 Measurement Error : 2rpm
 Start-up Compensation Timer : 0~99 seconds
 Instrument Allowable Temperature : -10°C~60°C
 Enclosure Rating : IP54 or equivalent
 Cable Gland : G3/4

■ Outline Drawing

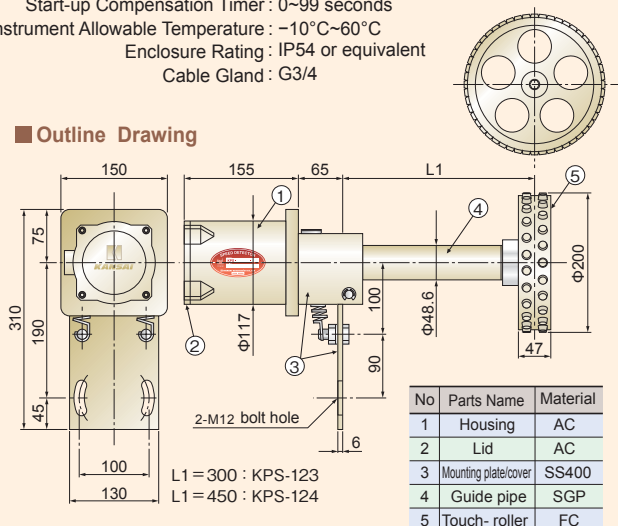

■ Mounting Drawing KPS-123/124

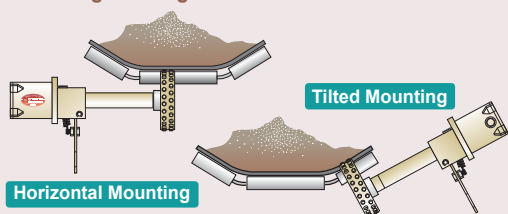

Best suitable for detecting level in a chute or chute-clogging

TC-3 Tilt Switch

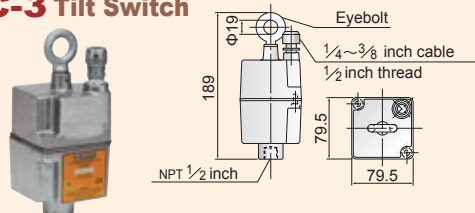

- It houses steel ball inside, and, when the body gets upright, the steel ball centers itself on a microswitch.
- When the body is tilted at 17° or more, the steel ball rolls off to deactivate the microswitch and switch the contact.

■ SPECIFICATION

Body Weight : about 1.3kg (cast aluminum) 2 or 3 wire system
 Output contact : SPDT
 Contact Capacity : 250VAC (10A)
 Temperature : -10 ~+80°C
 Enclosure Rating : IP56
 Cable Gland : 1/4~3/8 inch cable 1/2 inch thread

KEL-2 Leak Type Level Switch

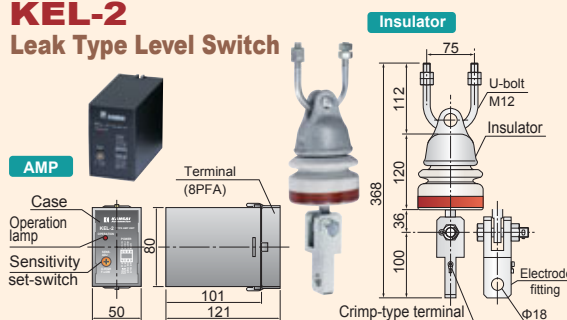

- It can be used for all products including sand as building materials, gravel, crushed rocks and so on as long as they contain some moisture.
- It is easy to set the sensitivity

■ Specification

Power Source : 105/210VAC ±10% 50/60Hz
 Output contact : SPDT
 Contact Capacity : 250VAC (10A)
 Detecting Sensitivity : Max about 10MQ~min about 30kΩ
 Setting Sensitivity : 16 Steps variable between Max & Min
 Ambient Temperature : 0~+50°C
 Indication Light : Actuation Indicating Light(light on detection)

MWS2-24TN/RN Microwave Type Level Switch

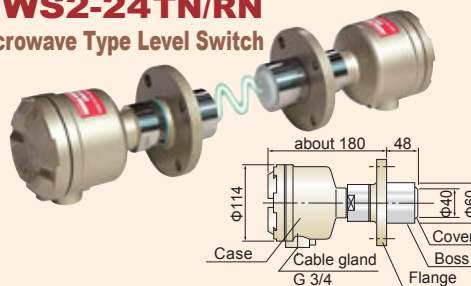

- It may hardly be affected by dirt, fouling, or scale adhesion on the sensing surface.
- Adoption of the high frequency at 24GHz enables its detectability stable even under the dust environment.

■ Specification

Power Source : 105/210 VAC ±10% 50/60Hz
 Power : Transmitter 2VA consumption Receiver 5VA
 Frequency : 24GHz
 Detection range : 15m, 25m, 35m (Switching by Range SW)
 Output contact : SPDT
 Contact Capacity : 250VAC 5A
 Delay Function : ON Delay, variable about 10 sec. at the maximum
 Ambient : -20°C~+60°C
 Temperature
 Enclosure Rating : IP66 or equivalent
 Flange : 5K 50A (AC) JIS

FLOW SWITCH/SENSOR Flow detection for Powder / Granules / Lump !

Lump Flow / Upper Limit Detection

KP-810

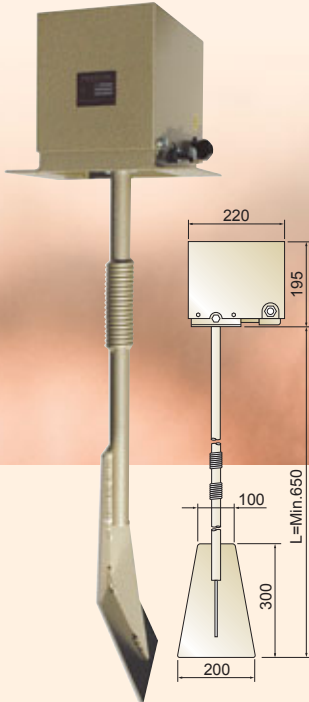

- Good for flow/level detection at the places requiring robustness, including but not limited to coal, crushed rock and mineral ore.
- Protected by a spring, the shaft is structurally robust to overload.
- Output Contact : SPDT×2
- Contact Capacity : 250VAC 10A
- Standard Operating Angle : about 10°, 15°
- Enclosure Rating : Equivalent to IPX3

Cover	SPCC
Housing	SPCC
Mounting Platform	SS400
Stopper	SS400
Torque Adjusting Spring	SWP
Sensing Plate	SPCC
Cable Gland	Adaptable Cable Φ8-Φ12

Flow Detecton On Conveyor

KP-820

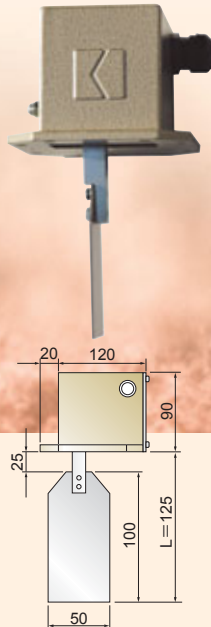

(Standard dimensions)

- Good for flow detection on conveyer.
- Torque adjusting being at your complete discretion, it can be used for low density as well.
- The materials of sensing plate(SS, Rubber, SUS) can arbitrarily be selected.
- Output Contact : SPDT×1
- Contact Capacity : 250VAC 5A
- Standard Operating Angle : about 15°
- Enclosure Rating : Equivalent to IP43

Housing	AC
Lid	SPCVC
Spindle Rod	SS400
Sensing Plate	SS304
Cable Gland	Adaptable Cable Φ8-Φ12

Flow Detection In Tilted Chute

KP-830

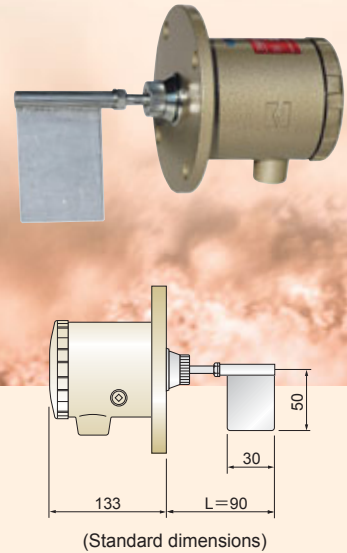

(Standard dimensions)

- Good for detection of falling objects inside a tilted chute.
- It can also be used to detect flow inside a pipe.
- L dimensions can arbitrarily be selected.
- Flange : 5K65A JIS or equivalent
- Output Contact : SPDT×1
- Contact Capacity : 250VAC 5A
- Standard Operating Angle : about 25°
- Enclosure Rating : Equivalent to IP55

Housing/Flange	AC
Paddle	304SS
Shaft	304SS
Seal Coupling	C3604
Torque Adjusting Hole	3/8 plug
Cable Gland	G 1/2

*Please specify the operating direction.

Install the sensing plate so that it may feel products that are being carried on a conveyor or that are being run out through the chute exit., and it will detect the presence of passing products. You can change the torque and sensing angle depending on their nature. (except KP-4 and KPG-840)

KP-810, KP-820, KP-4, KPG-840, KP-830

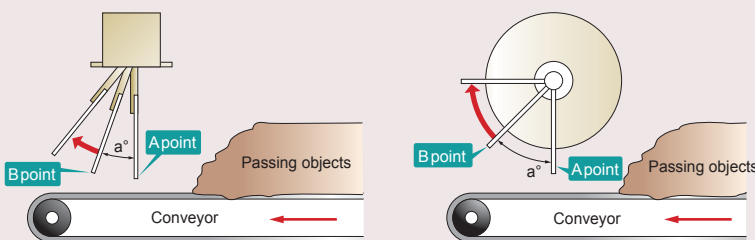

A: Blind zone B: Detection point a°: Sensing angle

As illustrated on the left, the sensing plate is at A-point when there is no passing object on a conveyor.

With a passing object drawing near, a signal turns on when the sensing plate comes to B-point.

When the passing object is gone, the sensing plate returns to A-point in consequence of the internal reversion spring and the tare of the sensing plate, and the signal turns off

*The operating angle(a°)of the sensing plate is set to the standard value upon factory shipment

Flow Detection On Conveyor

KP-4

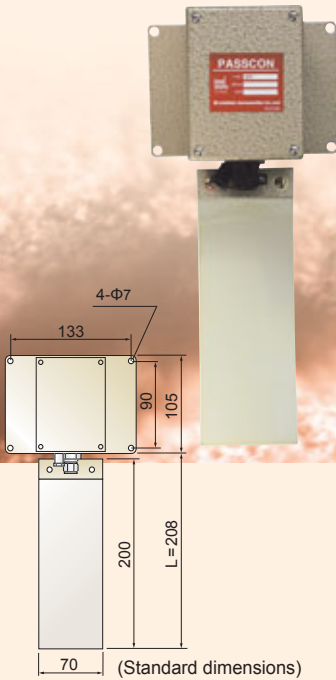

- Specially made for flow detection on conveyor.
- Simplified Dusttight Type
- Sensing Plate of urethane rubber is only available.
- Wall-mounted only Type
- Output Contact : SPDT×1
- Contact Capacity : 250VAC 10A
- Operating Angle : about 5°(fixed)
- Enclosure Rating : Equivalent to IP43.

Housing/Lid	SPCC
Lever	400SS
Spindle	SPCC
Sensing plate	Urethane Rubber
Cable gland	Adaptabie cable Φ6~Φ12

d2g4 Flame-proof Explosion-proof

KPG-840

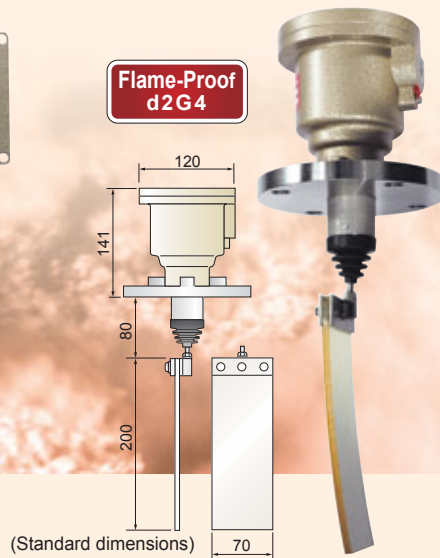

- Being of the structure of Flame-proof Explosion-proof, it can be used in the hazardous areas where flammable dust due to coal and so on comes into being or flammable gas exists.
- The switch part and sensing part being are completely by separated magnet coupling system Seal bellow assure a correct performance without being affected by dust and so on.
- The sensing plate is made of urethane rubber that is abrasion-resistant.
- Flange : JIS5K65A
- Output Contact : SPDT×1
- Contact Capacity : 250VAC 5A
- Operating Angle : 15°(Fixed)
- Enclosure rating : IP67

Case	AC
Mounting flange	304SS
Seal bellows	NBR
Sensing plate	Urethane rubber
Cable gland	G 1/2
NIIS	No. T29432

Microwave Type Flow Sensor

KFD-1

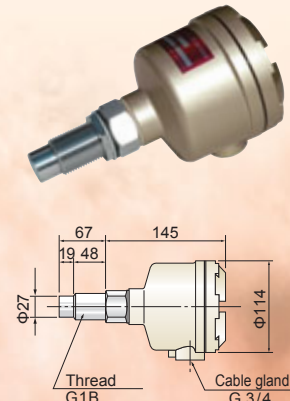

- Our unique circuit technology has been upgraded not to overlook even a grain.
- Our 24GHz technology has made it possible to sense through an intermediate barrier such as glass or synthetic resin.
- It may hardly be affected by smudges on the sensing surface or scale adhesion due to our 24GHz technology.
- It can detect flow in both small and large quantity if its sensitivity is properly adjusted.

■ Specification

- Power Source : 105/210VAC ±10% 50/60Hz
- Power Consumption : 5VA
- Output Contact : SPDT×1
- Contact Capacity : 250VAC 5A
- Allowable temperature : -10~+55°C
- Allowable pressure : 490kPa
- Sensing distance : Max. 1.5m (depend on object)
- Frequency : 24.2GHz
- ON delay : Adjustable 10 sec at the max.
- OFF delay : Adjustable 10 sec at the max.
- Enclosure Rating : IP67

■ KP-830 Torque Adjustment

Regarding the torque adjustment, for reversion and detection, remove the 3/8 plug and turn the screw inside with a small minus screw driver.

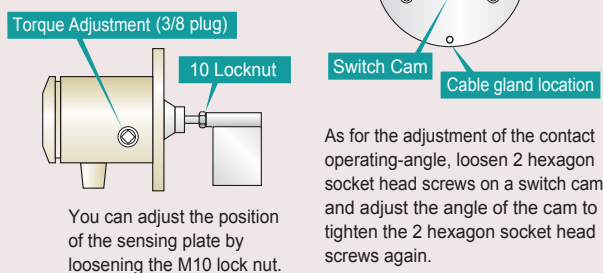

■ Wiring Diagram

KP-810

Micro Switches1 Micro Switches2

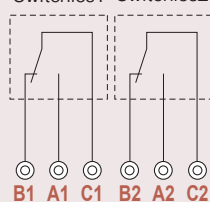

	KP-820 KP-830 KP-4 KP-900	KPG-840
--	------------------------------------	---------

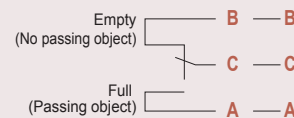

Conveyor peripherals, lined up with A broad range of products to detect

Danger Malfunction Flow Control Alarm

Products meeting all these requirements

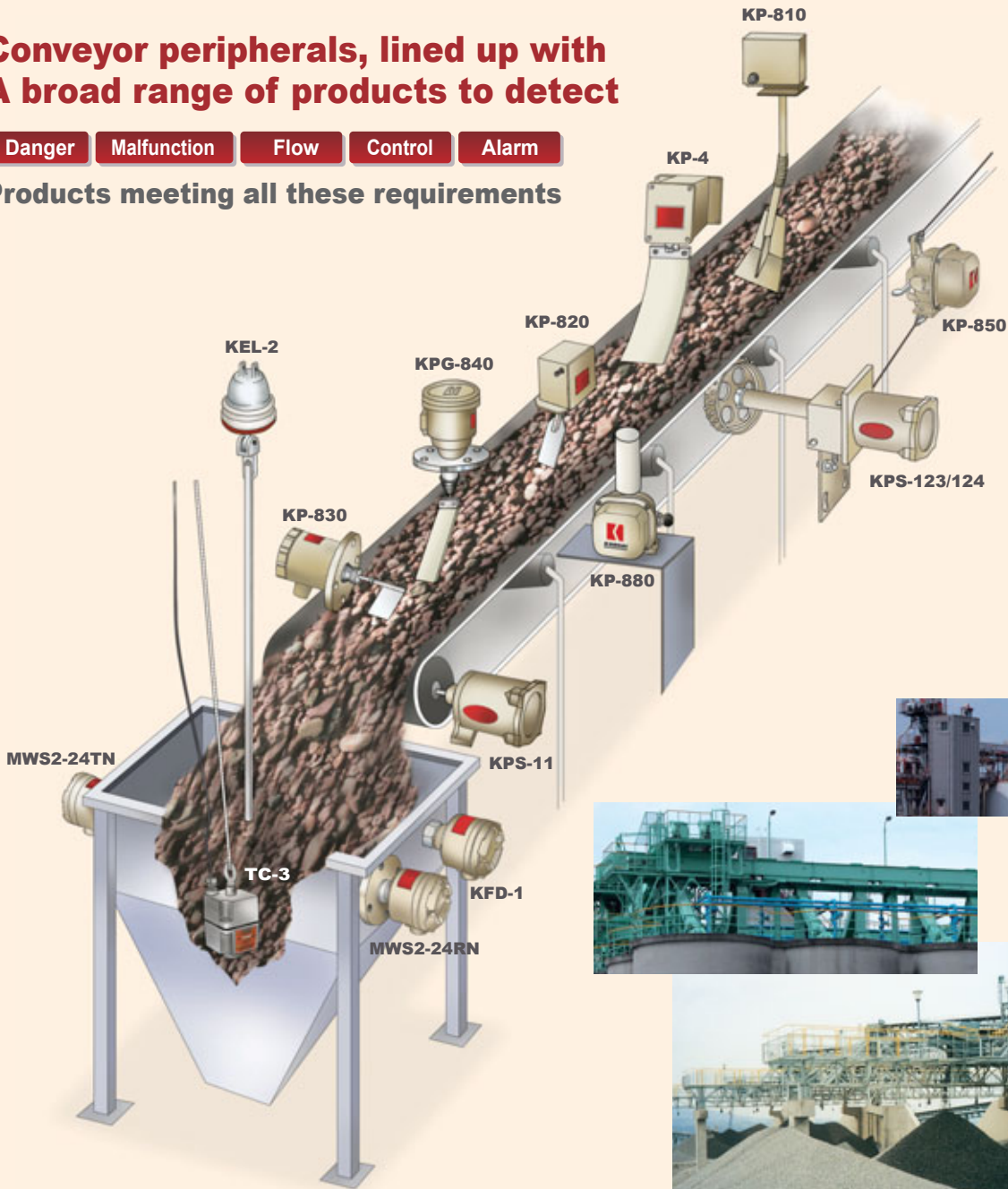

Line of business

- Rotary Paddle Type Level Switch
- Vibration Type Level Switch
- Swing Type Level Switch
- Acoustic Level Switch
- Capacitance Type Level Switch
- Capacitive Proximity Sensor
- Capacitance Type Level Indicator
- Diaphragm Type Level Switch
- Tiit Switch
- Leak Type Level Switch
- Microwave Type Switch
- Sounding Bob Type Level Indicator
- Flow Switch
- Conductance Type Level Switch
- Float Switch
- Float Type Level Indicator
- Ultrasonic Type Level Indicator
- Equipments For Conveyor Lines
- Dust Monitor System
- Zirconia Oxygen Analyzer
- Laser Type Level Indicator
- RADAR Type Level Indicator
- On-line Sensors for Accurate Liquid Analysis
- Ultrasonic Flow meter

*Please be sure to read USER'S GUIDE, Installation & Operation Instructions before using the instrument.

*The specifications herein may be subject to change without advance notice.

All-round Manufacturer of Level Controllers for Powder, Granules and Liquid

KANSAI Automation Co., Ltd.

Headquarters :

2-14, Togano-cho, Kita-ku, Osaka 530-0056, Japan

TEL. 81-6-6312-2071 FAX. 81-6-6314-0848

e-mail: info@kansai-automation.co.jp

<http://www.kansai-automation.co.jp>

Tokyo Branch : 1-29-6, Hamamatsu-cho, Minato-ku, Tokyo 105-0013, Japan
TEL. 81-3-5777-6931 FAX. 81-3-5777-6933

Nagoya Office : 3-31-27, Uchiyama, Chigusa-ku, Nagoya 464-0075, Japan
TEL. 81-52-741-2432 FAX. 81-52-741-1588

Kyushu Office : 1-2-39, Asano, Kokura Kita-ku, Kitakyushu 802-0001, Japan
TEL. 81-93-511-4741 FAX. 81-93-511-4580



Agent