

TALOS[®]



Operating Instructions

Configurable basic module

TB - I1403

ZANDER GmbH & Co. KG
Am Gut Wolf 15
52070 Aachen, Germany
info@zander-aachen.de
www.zander-aachen.de

Part-No.: E61-054-00
Revision: H09

Engl. translation.

Subject to technical modifications,
no responsibility is accepted for the
accuracy of this information.

Contents

1. About this document	5
1.1 Scope	5
1.2 Target group	5
.....	5
1.3 Key to symbols.....	6
1.4 Additional documents	7
2. General safety instructions	8
3. About this device	8
3.1 Scope of delivery and accessoires	9
3.2 Correct use	11
3.3 Exclusion of liability and warranty	11
3.4 Function	11
3.4.1 Predefined standard configurations	11
3.4.2 Adjustable parameters	12
3.4.3 Password-protected configuration	12
3.5 Display elements and switches	12
3.5.1 Display	13
3.5.2 Rotary pushbutton	13
3.6 Memory card (optional)	14
3.7 Connections	15
3.8 Block diagram	16
4. Mounting	16
4.1 Mounting evaluation unit	17
5. Electrical connection	17
5.1 Safety in case of faults	18
5.2 Fuse protection for power supply	18
5.3 Inputs	18
5.3.1 Safety inputs	

5.3.2 Control inputs	19
5.4 Outputs	19
5.4.1 Safety outputs.....	19
5.4.2 Auxiliary outputs and group outputs	20
5.4.3 Pulsed outputs	20
5.5 Connection example	21
5.6 Connect devices	22
6. Setup.....	23
6.1 What happens during start?	23
7. Operation.....	24
7.1 Using rotary pushbutton	24
7.2 Menu structure	25
7.3 Setting device to stop menu (menu Conf)	26
7.4 Loading configuration	27
7.5 Setting time delay	28
7.6 Changing password.....	29
7.7 Using diagnostics (menu DIA).....	30
7.7.1 Displaying status of the inputs and outputs	30
7.7.2 Displaying parameters TI1 ... TI3	31
8. Troubleshooting	32
8.1 General faults	32
8.2 Fault with fault number.....	33
9. Inspection, maintenance and replacement	37
10. Resetting the device to factory settings	38
11. Technical data	39
12. Safety characteristics according to EN ISO 13849-1.....	41
13. Dimension drawings	42
14. Service.....	43
15. Declaration of conformity	44

1. About this document







1.1 Scope

This document is valid for configurable basic module TALOS TB-I1403 (Order-No.: 472600); TB-I1403m (Order-No.: 472601) and TB-I1403h (Order-No.: 472602).

1.2 Target group



Specialist electricians and assembly, setup and service specialists who possess special knowledge in working with safety components.

1.3 Key to symbols

Symbol/depiction	Significance
	Printed document
	Document is available for download at www.zander-aachen.de
	Document on CD
	This section is applicable only if the memory card is used
 Danger, warning, caution	Safety precautions Danger of death or severe injuries Warning about possible injuries Caution - device damage possible
	Important information
TIP	Tip / useful information
bAck, DIA, Pr05 etc.	Display texts

1.4 Additional documents

The overall documentation for this device comprises the following documents:

Document title	Contents	
Operating instructions	(this document)	
Logic manual	Description of the standard configurations in the device www.zander-aachen.de/TALOS_TB-I1403	
Optional: Logic manual for customer-specific configuration	Customer-specific documentation	



Important!

Always read all documents to obtain a complete overview of safe installation, setup and operation of the device. The documents can be downloaded from www.zander-aachen.de.

2. General safety instructions

Safety components fulfill personal protection functions. Incorrect installation or tampering can lead to fatal injuries to personnel.

Safety functions must not be bypassed, removed or tampered with in other ways.

Check the safe function of all components of the safety application

- after any setup work
- after the replacement of any component
- after an extended period without use
- after every fault

Independent of these checks, the safe function of the safety application should be checked at suitable intervals as part of the maintenance schedule.

Installation, parameter assignment, setup, maintenance and decommissioning must be performed only by authorized experts

- who are familiar with the correct handling of safety components
- who are familiar with the applicable EMC regulations
- who are familiar with the applicable regulations on health and safety and accident prevention
- who have read and understood the complete documentation (for the components of the complete documentation, see „1.4. Additional documents“ on page 6).

3. About this device

3.1 Scope of delivery and accessoires

Scope of delivery

- Configurable basic module TB-I1403 (Order-No.: 472600), TB-I1403m (Order-No.: 472601), TB-I1403h (Order-No.: 472602)
- Holder for memory card, already in the device
- These operating instructions

Required accessoires



Note!

Connection terminals are not included in the scope of delivery. Please order separate connection set (see ordering table below).

Designation	Version	Order no.
Connection set	2 sets screw terminals - EKLS4	472592
	2 sets spring terminals - EKLZ4	472593

Optional accessories

- Memory card (only for customer-specific configuration)

3.2 Correct use

The configurable evaluation unit *TB-I1403* is used to evaluate safety-related signals in safety circuits according to EN 60204-1. The function depends on the configuration loaded in the device. Safety category 4, PL e according to EN ISO 13849-1 can be achieved in this case (depending on the external circuit and the selected configuration).

The safety function involves safely switching off the safety outputs depending on the input signals and the selected logic function.

The devices are not allowed to be opened, tampered with, or modified.

The permissible operating parameters must be observed during operation (see section "Technical data"). Before the device is used, a risk assessment must be performed on the machine, e.g. in accordance with:

- EN ISO 13849-1, Safety of machinery - Safety-related parts of control systems - Part 1: General principles for design, Appendix A
- EN ISO 12100, Safety of machinery - General principals for design - Risk assessment and risk reduction
- IEC 62061, Safety of machinery - Functional safety of safety-related electrical, electronic and programmable electronic control systems

Depending on the type of machine or installation, additional specifications may have to be taken into account.

Correct use includes compliance with the relevant requirements for installation and operation, particularly

- EN ISO 13849-1, Safety of machinery - Safety-related parts of control systems - Part 1: General principles for design
- EN 60204-1, Safety of machinery - Electrical equipment of machines - Part 1: General requirements

For further information, refer to the aforementioned documents.

**Note!**

- The user is responsible for the integration of the device in a safe overall system. For this purpose, the overall system must be validated, e.g. in accordance with EN ISO 13849-2
- If a data sheet is included with the product, the information on the data sheet is applicable

3.3 Exclusion of liability and warranty

In case of failure to comply with the conditions for correct use stated above, or if the safety instructions are not followed, or if any servicing is not performed as required, liability will be excluded and the warranty void.

3.4 Function

The function of the device depends on the loaded configuration. The logic function stored in the configuration determines how the input signals are evaluated and how the outputs switch.

The maximum number and function of sensors that can be connected depends on the selected configuration.

Due to the combination of dynamic polling of the sensors and the redundant, diverse design of the safety electronics with redundantly controlled safety outputs, the evaluation unit will enter the safe state with every detectable fault.

3.4.1 Predefined standard configurations

The 15 predefined standard configurations stored in the device's internal memory can cover numerous applications.

You can activate the desired configuration via the configuration menu of the device.

Configuration `Pr00` is loaded as the default setting on delivery. Configuration `Pr00` does not have a function; inputs are not evaluated and outputs are switched off. However, the state of the inputs is registered and displayed in the menu `DIA`.



Detailed information about the standard configurations can be found in the document „Logic manual for configurable basic device TB-I1403“. The document is available for download on the internet.

3.4.2 Adjustable parameters

Depending on the configuration, time-dependent parameters that can be set directly on the device can be available for safety outputs.



Detailed information about changing the configuration can be found in the chapter „7. Operation“

3.4.3 Password-protected configuration

The active configuration and the parameter settings are protected by a password (3 digits).

3.5 Display elements and switches

All important functions and informations are directly accessible on the device.

	<table border="1"> <thead> <tr> <th>Item</th> <th>Description</th> </tr> </thead> <tbody> <tr> <td>1</td> <td>Display</td> </tr> <tr> <td>2</td> <td>Rotary pushbutton</td> </tr> <tr> <td>3</td> <td>Connection terminals, pluggable (please order separately)</td> </tr> <tr> <td>4</td> <td>Slot with holder for optional memory card</td> </tr> </tbody> </table>	Item	Description	1	Display	2	Rotary pushbutton	3	Connection terminals, pluggable (please order separately)	4	Slot with holder for optional memory card
Item	Description										
1	Display										
2	Rotary pushbutton										
3	Connection terminals, pluggable (please order separately)										
4	Slot with holder for optional memory card										

3.5.1 Display

Depending on the menu item, the display shows different types of information. The display frame indicates the display areas for inputs and outputs in the diagnostic menu (DIA)

	<table border="1"> <thead> <tr> <th>Item</th> <th>Description</th> </tr> </thead> <tbody> <tr> <td>1</td> <td>Display area for safety inputs (channel 1)</td> </tr> <tr> <td>2</td> <td>Display area for inputs (channel 2)</td> </tr> <tr> <td>3</td> <td>Display area for safety outputs</td> </tr> <tr> <td>4</td> <td>Display area for control inputs</td> </tr> </tbody> </table>	Item	Description	1	Display area for safety inputs (channel 1)	2	Display area for inputs (channel 2)	3	Display area for safety outputs	4	Display area for control inputs
Item	Description										
1	Display area for safety inputs (channel 1)										
2	Display area for inputs (channel 2)										
3	Display area for safety outputs										
4	Display area for control inputs										



Caution!

The auxiliary outputs are not shown on the display.

3.5.2 Rotary pushbutton

The rotary pushbutton permits the following actions:

Function	Symbol
Change menu items and modify values by <ul style="list-style-type: none"> turning 	
Select and confirm by <ul style="list-style-type: none"> pressing briefly 	 Enter
Cancel input and move back one menu level by <ul style="list-style-type: none"> pressing for a long time (min. 2 seconds) 	 Esc (2s)

3.6 Memory card (optional)

The device can be expanded with a memory card. The card offers the following advantages:

- Memory for customer-specific configuration



Detailed information about using the memory card can be found in the logic manual for your customer-specific configuration (optional).

	Important: Switch the device off before inserting or removing the memory card.	
	Item	Description
	1	Card holder with memory card
2	Ejector	

3.7 Connections

	Terminal	Description
	A1	Power supply + 24V DC
	A2	Power supply 0V
	X1 ... X3	Control input, e.g. for start mode (auto/manual) and feedback loop
	T1, T2	Pulsed outputs for short circuit monitoring
	I1-1 ... I7-1	Safety inputs 1 ... 7 (channel 1)
	I1-2 ... I7-2	Safety inputs 1 ... 7 (channel 2)
	O1 ... O3	Safe semiconductor outputs
	C0 ... C5	Auxiliary outputs



Detailed information about electrical connection can be found in the chapter „5. Electrical connection“.

3.8 Block diagram

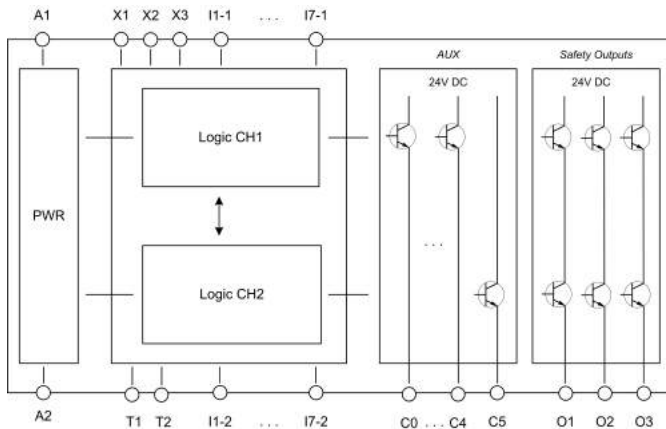

4. Mounting

4.1 Mounting evaluation unit

Note:

- The device must be mounted in a control cabinet with a minimum degree of protection of IP 54
- Mount on a 35-mm mounting rail according to EN 60715
- Mount with the ventilation slots facing up for optimal heat dissipation
- Maintain a mounting distance of 5 mm from adjacent devices that generate heat
- Ensure adequate heat dissipation in the control cabinet
- Mount the device so that the memory card holder and the control and display elements are easily accessible

5. Electrical connection



WARNING

Loss of the safety function due to incorrect connection.

- The connected sensors and actuators must match the selected configuration
- Auxiliary outputs must not be used as safety outputs
- Use pulsed outputs only for short circuit monitoring of this device
- Do not connect external voltage on outputs
- The safe inputs Ix-1/Ix-2 and the control inputs X1/2/3 must be controlled with p-switching

Additionally note the following:

- All electrical connections must either be isolated from the mains supply by safety transformers (SELV/PELV) according to IEC 61558-2-6 with limited output voltage in the event of a fault, or by other equivalent isolation measures
- All electrical outputs must have an adequate protective circuit for inductive loads
The outputs must be protected with a free-wheeling diode for this purpose
- Tighten screws on the connection terminal with a torque of 0.6 ... 0.8 Nm

5.1 Safety in case of faults

- The operating voltage A1/A2 is reverse polarity protected
- All outputs are short circuit-proof
- Short circuit detection (short circuit between any two conductors; the function depends on the loaded configuration)
- Earth fault detection (only switch-off of the safe outputs; no display possible. The prerequisite is wiring with secondary-side function grounding according to EN 60204)

5.2 Fuse protection for power supply

The supply line to the device (terminal A1) must be protected with a suitable fuse (see „12 technical data“).

5.3 Inputs



Detailed information about the input types can be found in the description of the loaded configuration in the document „Logic manual for configurable basic device TB-I1403“. The document is available for download at www.zander-aachen.de.

5.3.1 Safety inputs

The device can evaluate different safe input types. The input types used are defined in the respective configuration. The following input types can be evaluated:

- 2-channel contacts (NC contacts) with short circuit monitoring
- 2-channel contacts (NC contacts) without short circuit monitoring
- antivalen contacts (NO contacts / NC contacts) with additional test pulses
- antivalent contacts (NO contacts / NC contacts)
- 2-channel OSSD
- 1-channel contacts (NC contacts) with short circuit monitoring
- 1-channel contacts (NC contacts) without short circuit monitoring
- 1-channel OSSD
- Group-Input to connect several TB-I1403 (see „5.7 Connect devices“)

5.3.2 Control inputs

The device can evaluate different safe input types. The input types used are defined in the respective configuration. The following input types can be evaluated:

- simple control input
- feedback loop for testing downstream devices with optional start button (not monitored)
- monitored start button with optional feedback loop

5.4 Outputs



Detailed information about the output types can be found in the description of the loaded configuration in the document „Logic manual for configurable basic device TB-I1403“. The document is available for download at www.zander-aachen.de.

5.4.1 Safety outputs

The device possesses the safety outputs (O1 ... O3). The switching behavior is determined by the loaded configuration.

The following output types are available:

- pulsing output
- non-pulsing output

If only one safety output of the device is to be used for control (e.g. of downstream contactors), faults involving a short circuit between the safety output and, for example, the power supply must be excluded.

With reference to EN ISO 13849-2 Tables D.4 and D.5, this exclusion can be provided if:

- the cables are inside an electrical enclosure and
- the enclosure meets the relevant requirements (see EN 60204-1 or IEC 60204-1)

5.4.2 Auxiliary outputs and group outputs

The device possesses six monitoring outputs (C0 ... C5). This switching behavior is determined by the loaded configuration.

The following output types are available:

- auxiliary output
- auxiliary output with increased output current (only C0)
- group output to connect several TB-I1403 (only C4 and C5) (see „5.6 Connect devices“)

5.4.3 Pulsed outputs

The pulsed outputs (T1 and T2) serve the purpose of short circuit monitoring ahead of connected safety devices (see example below).

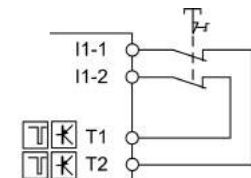

Timing-Diagramme

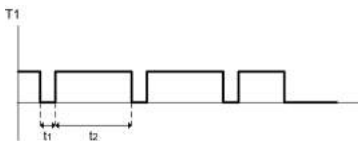

Pulse on T1:

1 ms pause time (t_1); 31 ms pulse time (t_2)

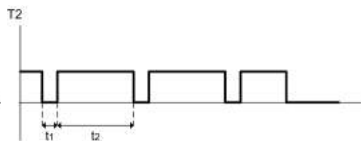

Pulse on T2:

1 ms pause time (t_1); 33 ms pulse time (t_2)

5.5 Connection example

(suitable for configuration PR01)

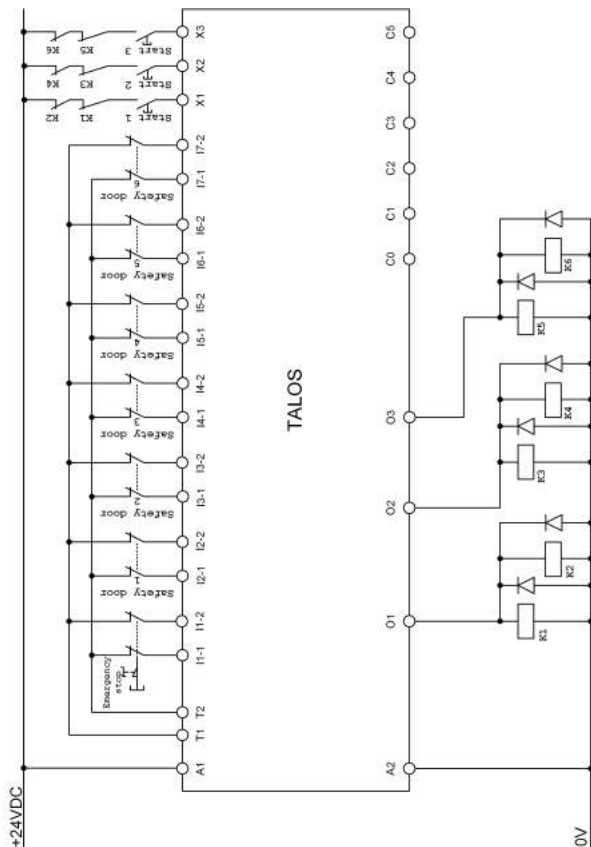

5.6 Connect devices

For complex safety applications, two TB-I1403 can be connected together.

The two auxiliary outputs for group signals C4 and C5 of the first TB-I1403 have to be connected on two safe inputs of the second TB-I1403 (refer to illustration).

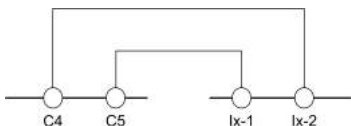

Important: Auxiliary outputs, which are configured as group signals must be used only to connect devices of the TALOS family.

Groupsignals are determined by the loaded configuration.

For more information contact the support of ZANDER AACHEN.

6. Setup



WARNING

Risk of injury due to unexpected machine startup.

- Follow the instructions in the chapter on operation
- Persons must stay out of the machine's danger area

6.1 What happens during start?

On the first start, the device loads the last configuration and initializes itself. The **BUSY** indication flashes on the display during initialization. The loaded configuration (factory setting **Pr00**) is displayed after initialization. Configuration **Pr00** does not have a function; inputs are not evaluated and outputs are switched off. However, the state of the inputs is registered and displayed in the menu **DIA**.



Note!

In operation instructions, the machine manufacturer must specify the designated configuration and the measures required for safe setup.

For the device to function properly, the designated configuration must be loaded. It might be necessary to enter values for the parameters **TI1** ... **TI3**. For the settings to be made, refer to the configuration description in the document „*Logic manual for configurable basic device TB-I1403*“.



Detailed information about operation and the menu structure can be found in the chapter „7. Operation“.

7. Operation

The most important information and settings are directly accessible with the aid of the display and the rotary pushbutton.

The following information can be viewed directly on the device:



- Status of inputs and outputs (menu **DIA**, chapter 7.7)
- Set time delay for parameters **TI1...TI3** (menu **DIA**, chapter 7.7)

The following settings can be made directly on the device:

- Load configuration (**Pr00 ... Pr15**, chapter 7.4)
- Set time delay for parameters **TI1 ... TI3** (chapter 7.5)
- Change password (**Pin**) (chapter 7.6)

7.1 Usign rotary pushbutton

Operation takes place exclusively with the aid of the rotary pushbutton below the display.

Function	Action	Symbol
Change menu item, change value	turn	
Confirm selection / input	Press briefly	 Enter
Cancel input and move back by one menu level	Press for at least 2 s	 Esc (2s)

7.2 Menu structure



Note!

The following diagram is a general overview. Detailed information can be found in the chapters 7.3 ... 7.7.

With the item **bAck** you move back by one menu level.

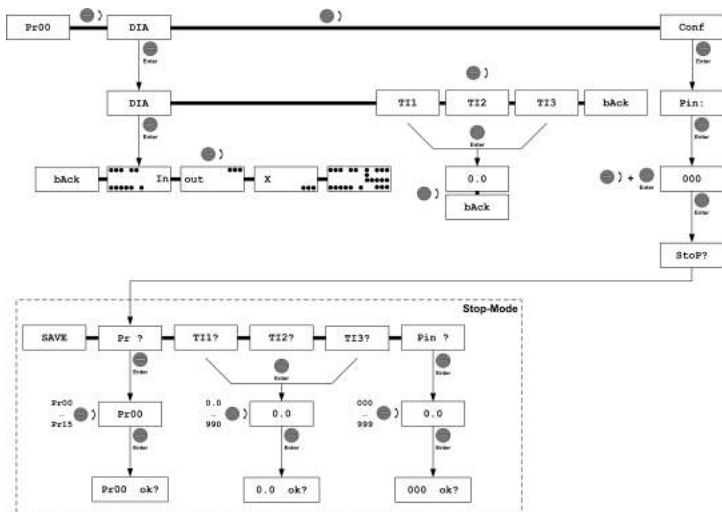

7.3 Setting device to Stop mode (menu Conf)



WARNING

Settings can be made only in Stop mode. With the change to Stop mode, all device outputs switch to the safe state. Important: Any programmed time delays will be taken into account on switch-off. This can lead to machine damage if processes are in operation. Set the machine to a suitable operating state first. Changes are not stored until the change to run mode

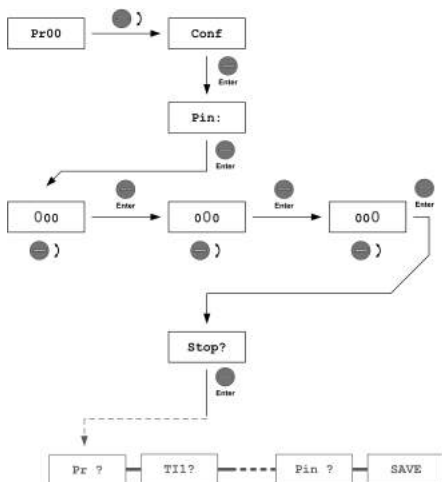

1. Change to menu Conf
2. Enter the password (factory setting 473)
3. Set the device to Stop mode.

→ BUSY flashes and indicates that the device is ending normal operation. The following display appears after the change: Pr?.

You can make the desired setting.



NOTE

Settings are not saved until you leave the menu Conf via the menu SAVE (refer to chapters 7.4 ... 7.6).

7.4 Loading configuration

16 configurations (Pr00 ... Pr15) are available for selection in the device (factory settings: Pr00, without function).



Detailed information about the standard configurations can be found in the document „Logic manual for configurable basic device TB-11403“. The document is available for download on the Internet.

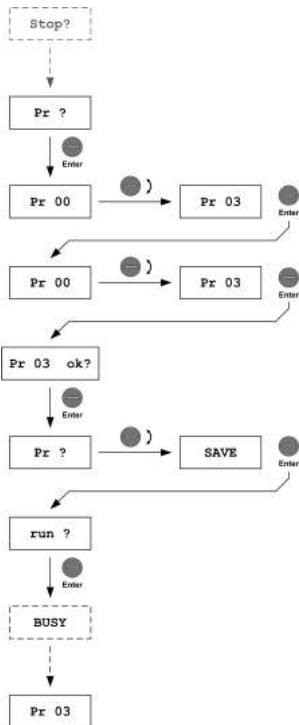

1. Set the device to Stop mode
(see chapter 7.3)

2. Select configuration, e.g. Pr03. The process must be repeated for safety reasons.

3. Confirm the selection

4. Change other parameters or SAVE settings.

5. Load configuration

→ New configuration is loaded

→ Device is in normal operation again

7.5 Setting time delay

A delay time can be set in the parameters TI1 ... TI3.

The parameters are polled by the configuration logic function and are taken into account during execution. Example: switch-off delay for an output.

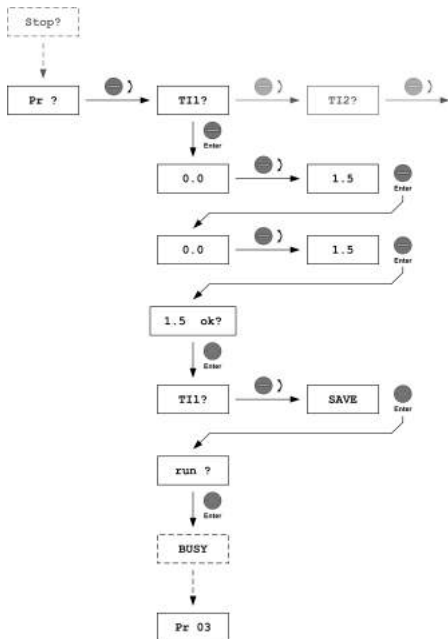

1. Set device to Stop mode (see chapter 7.3).
2. Select parameter, e.g. TI1.

3. Set value, e.g. 1.5

TB-I1403: [s]

TB-I1403m: [min]

TB-I1403h: [h]

The process must be repeated for safety reasons.

4. Confirm selection.

5. Change other parameters or SAVE set-tings.

6. Save settings

→ Device is in normal operation again

7.6 Changing password

A password (Pin) must be entered to prevent the device configuration from being changed by unauthorized persons or the device from being set to Stop mode unintentionally. The factory setting is 473. Change the password after initial setup. The password should not be too simple.

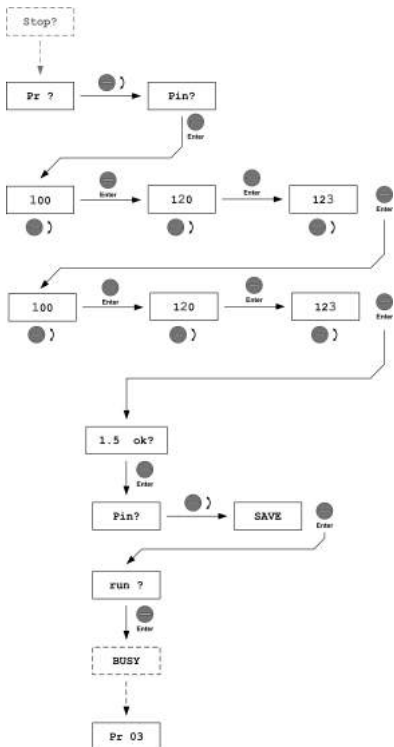

1. Set device to Stop mode (see chapter 7.3)

2. Select Pin

3. Set value, e.g. 123. The process must be repeated for safety reasons

4. Confirm selection

5. Change other parameters or SAVE settings

6. Save settings

→ Device is in normal operation again

7.7 Using diagnostics (menu DIA)

Menu DIA provides a rapid overview of

- The status of the inputs and outputs (submenu I-O)
- The set time delays (submenus TI1 ... TI3)

7.7.1 Displaying status of the inputs and outputs

In normal operation, change to the menu DIA and then to the submenu I-O.

The table below explains the displays. Change display with .

If the device is switched off with one of these displays, this last display will be reloaded instead of the last configuration on restart.

Display in submenu I-O	Description of the status
	<p>Display of the safety inputs (in)</p> <p>The example shows the following status:</p> <ul style="list-style-type: none"> • Channel 1: HIGH at I1-1, I2-1, I5-1 • Channel 2: HIGH at I2-1, I2-2, I4-2, I5-2 • LOW at the remaining safety inputs
	<p>Display of the safety outputs (out)</p> <p>The example shows the following status:</p> <ul style="list-style-type: none"> • O1: HIGH • O2: LOW • O3: HIGH
	<p>Display of the control inputs (x)</p> <p>The example shows the following status:</p> <ul style="list-style-type: none"> • X1: HIGH • X2: LOW • X3: LOW
	<p>Joint display of inputs and outputs</p> <p>The status of all inputs and outputs are shown together in the display.</p>

7.7.2 Displaying parameters TI1 ... TI3

The set time delays can be displayed in the parameters TI1, TI2 and TI3 in normal operation. Change to the menu DIA and then to the submenu TI1 ... TI3 for this purpose.

The values are displayed in seconds. Example below: The display 1.5 in the parameter TI2 indicates that the currently set time delay is 1.5 s.

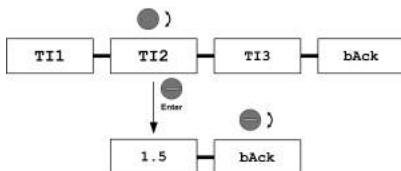

8. Troubleshooting

The device detects most faults and displays them with a fault number. Some faults cannot be displayed. They can be recognized based on an unexpected or missing device reaction.

TIP: Use the status display of the inputs and outputs in the menu `DIA` for troubleshooting.

8.1 General faults

Problem	Cause	Solution
Display does not show anything	Fault in the power supply	<ul style="list-style-type: none"> • Check correct wiring • Measure the voltage level if necessary
Unexpected switching behavior, wrong/no reaction	<ul style="list-style-type: none"> • Connected switch faulty • Wrong program selected 	<ul style="list-style-type: none"> • Check wiring • Check function of the connected devices • Check loaded configuration and change it if necessary

8.2 Fault with fault number



Note!

If your device displays a fault that is not listed here, please contact our Support department.



WARNING!

Parameterized delay times are taken into account.

Fault	Cause	Solution / Acknowledgement
Er01	Input pair I1-1 / I1-2: Difference time exceeded or single-channel switch off at two-channel input.	<ul style="list-style-type: none"> • Check wiring • Check function on the connected devices • Switch connected device off and on again
Er02	Input pair I2-1 / I2-2: Difference time exceeded or single-channel switch off at two-channel input.	
Er03	Input pair I3-1 / I3-2: Difference time exceeded or single-channel switch off at two-channel input.	
Er04	Input pair I4-1 / I4-2: Difference time exceeded or single-channel switch off at two-channel input.	
Er05	Input pair I5-1 / I5-2: Difference time exceeded or single-channel switch off at two-channel input.	
Er06	Input pair I6-1 / I6-2: Difference time exceeded or single-channel switch off at two-channel input.	
Er07	Input pair I7-1 / I7-2: Difference time exceeded or single-channel switch off at two-channel input.	
Er08	Input pair X1 / X2: Difference time exceeded or single-channel switch off at two-channel input.	

Fault	Cause	Solution / Acknowledgement
Er11	Stuck Start button input X1	<ul style="list-style-type: none"> • Check wiring • Check function of the connected devices • Switch connected device off and on again
Er12	Stuck Start button input X2.	
Er13	Stuck Start button input X3	
Er14	Second PIN input is different	<ul style="list-style-type: none"> • Repeat input • Automatic acknowledgement after 2 seconds
Er15	Second configuration number input is different	<ul style="list-style-type: none"> • Repeat input • Automatic acknowledgement after 2 seconds
Er16	Second time input is different	<ul style="list-style-type: none"> • Repeat input • Automatic acknowledgement after 2 seconds
Er17	Wrong PUK	<ul style="list-style-type: none"> • Repeat input (see chapter 10) • Automatic acknowledgement after 2 seconds
Er18	Wrong PIN	<ul style="list-style-type: none"> • Repeat input • Automatic acknowledgement after 2 seconds • If you forgot the password, you can restore the device to the factory settings by entering the PUK (see chapter 10).
Er19	Memory card missing; configuration could not be loaded	<ul style="list-style-type: none"> • Insert the correct memory card • Check whether it was inserted properly

Fault	Cause	Solution / Acknowledgement
Er49	Wait state	<ul style="list-style-type: none"> • Wait for next fault number
Er51	Pulsing error at input I1-1	<ul style="list-style-type: none"> • Check wiring for short circuits • Check assignment of the pulsed outputs T1 → Ix-2; T2 → Ix-1 • Acknowledgement by pushing button
Er52	Pulsing error at input I1-2	
Er53	Pulsing error at input I2-1	
Er54	Pulsing error at input I2-2	
Er55	Pulsing error at input I3-1	
Er56	Pulsing error at input I3-2	
Er57	Pulsing error at input I4-1	
Er58	Pulsing error at input I4-2	
Er59	Pulsing error at input I5-1	
Er60	Pulsing error at input I5-2	
Er61	Pulsing error at input I6-1	
Er62	Pulsing error at input I6-2	
Er63	Pulsing error at input I7-1	
Er64	Pulsing error at input I7-2	
Er65	Pulsing error at input X1	<ul style="list-style-type: none"> • Check wiring for short circuits • Check capacity load at the outputs • There may be an internal device fault. Contact the manufacturer's support
Er66	Pulsing error at input X2	
Er67	Pulsing error at input X2	
Er68	Output error at safety output O1	
Er69	Output error at safety output O2	
Er70	Output error at safety output O3	

Nr.	Ursache	Lösung / Quittierung
Er91 to Er99	Internal device fault	<ul style="list-style-type: none">• Check wiring of inputs and outputs for short circuits• Restart the device <p>If the fault persists:</p> <ul style="list-style-type: none">• Reset the device to the factory setting (see chapter 10) <p>If the fault persists:</p> <ul style="list-style-type: none">• Contact the manufacturer's support

9. Inspection, maintenance and replacement

**Warning!**

Loss of the safety function because of damage to the safety. In case of damage, the entire device must be replaced.

Regular inspection of the following is necessary to ensure trouble-free longterm operation

- Check the switching function
- Check the secure fastening of the device and the connections
- Check for soiling

No serving is required. Repairs to the device are only allowed to be made by the manufacturer.

**Note!**

The year of manufacture can be seen in the lower right corner of the rating plate.

10. Resetting the device to factory settings

**Caution!**

All settings will be lost on reset. Make a note of the settings before resetting.

Proceed as follows to reset the device to the factory settings:

1. Put the machine in a suitable operating state
2. Disconnect the device from the power supply
3. Restart the device while holding the rotary pushbutton down
→ PUK: is displayed
4. Enter the PUK: [825]
→ run - ok? is displayed
1. Press the rotary pushbutton to start the device with the factory settings.

11. Technical data

Electrical data	
Supply voltage U_B	DC 24 V
Allowable tolerance	$\pm 15\%$
Input current at U_B (all inputs activated / no load)	155 mA
Power consumption at U_B (all inputs activated / no load)	3.8 W
Display	14 x 5 Dot-Matrix
Power-On delay	9 s
Inputs	
Number	17
Input voltage	DC 24 V $\pm 15\%$
Input current	typ. 7 mA
Galvanic isolation	No
Signal-Level at "0"	min: 0 V max: 5 V
Signal-Level at "1"	min: 18 V max: U_B
Pulse suppression	10 ms
Max. switch on delay	800 ms (+ configured delay time)
Max. switching frequency	0.8 Hz
Safe semiconductor outputs	
Number	3
Structure	pnp-outputs, redundant
Max. output current	$U_B / 500$ mA
Max. capacity load	0,5 μ F per 10 mA output current
Max. pulse duration for selftests	< 3 ms
Galvanic isolation	No
Short circuit protection	yes
Max. switch off delay	60 ms (+ configured delay time)
Output voltage at "1" (max. load)	$U_B - 1$ V
Auxiliary outputs	
Number	6
Structure	pnp-outputs, single channel
Switching capability	C0: $U_B / 500$ mA C1 to C5: $U_B / 50$ mA

Galvanic isolated	no
Short circuit protected	yes
Output voltage at "1" (max. load)	U _B - 1 V
Pulsed outputs	
Number	4
Switching capability	DC 24 V
Pulse duration	1 ms
Galvanic isolated	no
Short circuit protected	yes
Environmental data	
Ambient temperature	0 °C to 50 °C
Storage temperature	-20 °C to 85 °C
Climatic suitability	93 % r.F. at +40 °C, not condensing
Vibration according EN 60068-2-64	
Frequency	10 Hz to 150 Hz
Max. acceleration	0.5 g
EMC	EN 61326-3-1
Overvoltage category	III
Pollution degree	2
Rated isolation voltage	50 V
Rated impulse withstand voltage	800 V
Mechanical data	
Degree of protection	IP20
Mounting	DIN rail according to EN 60715 TH35
Max. cable runs	1000 m at 0.75 mm ²
Line cross-section	0.25 - 2.5 mm ²
Measures	45 x 99 x 118 mm
Weight	190 g
Housing material	Polyamid PA6.6
Terminals	Plug-in terminals

12. Safety characteristics according to EN ISO 13849-1

The safety characteristics for a safety function of the TB-I1403 depends on the selected configuration and are determined by the subsystems.

Input - Logic - Output

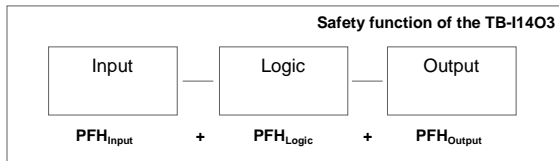

Subsystem	PL	Category	PFH [1/h]	T _M [years]	Note
Logic	e	4	5,38E-09	20	
Safe input; single channel	c	1	1,14E-06	20	
Safe input; dual channel	e	4	9,06E-10	20	
One safe output O _x	e	4	9,06E-10	20	Refer to chapter 5.4.1
Two safe outputs O _x , O _y	e	4	1,13E-09	20	Refer to chapter 5.4.1
Group signal output	e	4	9,06E-10	20	Refer to chapter 5.6

Example:

The safety characteristics for a safety function with safe two channel input and one safe output are:

Characteristics	
PL	e
Categorie	4
PFH	$PFH_{Input} + PFH_{Logic} + PFH_{Output} = 7,19E-09$ 1/h
T _M	20 years



Note!

Please find all safety characteristics for each configuration in its individual description.



Safety characteristics for all configurations can be found in the description of the loaded configuration in the document „Logic manual for configurable basic device TB-I1403“. The document is available for download at www.zander-aachen.de.

13. Dimension drawings

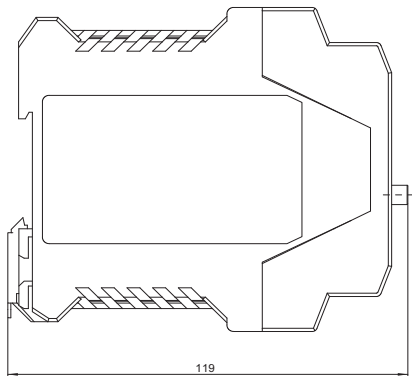
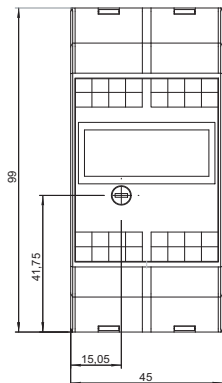

14. Service

If service support is required, please contact
H. ZANDER GmbH & Co. KG
Am Gut Wolf 15
52070 Aachen
Germany

Service telephone

Within Germany:
(0241) 910501-16
From abroad:
+49 241 910501-16

E-mail

info@zander-aachen.de

Internet

www.zander-aachen.de

15. Declaration of conformity

CE Konformitätserklärung EC Declaration of Conformity Déclaration de conformité

Hersteller: H. ZANDER GmbH & Co. KG
Producer: Am Gut Wolf 15 • 52070 Aachen • Deutschland
Fabricant:

Produktgruppe: Sicherheits-Not-Halt-System
Product Group: Safety emergency stop system
Groupe de produits: Système de sécurité d'arrêt d'urgence

Produkt Name Product Name Nom du produit	Anbringung der CE-Kennzeichnung Attaching of CE marking Application du marquage CE	Zertifikats-Nr. No of Certificate N° du certificat
TB-I1403.....2016		01/205/5420.01/16
SCB-02.....2016		01/205/5420.01/16
SCB-03.....2016		01/205/5420.01/16
SCB-04.....2016		01/205/5420.01/16

Die Produkte stimmen mit den Vorschriften folgender Europäischer Richtlinien überein:
The products conform with the essential protection requirements of the following European directives:
Les produits sont conformes aux dispositions des directives européennes suivantes:

2006/42/EG : Maschinenrichtlinie
2006/42/EG : Machinery directive
2005/42/EG : Directive <<Machines>>

2014/30/EG : EMV Richtlinie
2014/30/EG : EMC directive
2014/30/EG : Directive <<CEM>>

Die Übereinstimmung der bezeichneten Produkte mit den Vorschriften der o.a. Richtlinie wird, falls anwendbar, nachgewiesen durch die vollständige Einhaltung folgender Normen:
if applicable, the conformity of the designated products is proved by full compliance with the following standards.
Le strict respect des norme suivantes confirmé, s'il y a lieu, que les produits désignés sont conformes aux dispositions de la directive susmentionnée.

EN 60439-1:2005-01 EN 60947-1:2011-10 EN 60947-5-1:2010-04
EN 61000-6-2:2006-03 EN 61000-6-3:2011-09 DIN EN 61326-3-1:2008-11

Gemäß Zertifikat der benannten Stelle:
According to the certificate of the below mentioned organisation:
Selon de organisme notifié.

EN 62061:2005 + AC:2010+A1:2013+A2:2015 DIN EN ISO 13849-1:2015
IEC 61508 Parts 1-7:2010 IEC 61511-1:2016
EN 50156-1:2015 in extracts EN 746-2:2010 in extracts

Benannte Stelle / Notified body / Organisme notifié:
Nr. NB 0035
TÜV Rheinland Industrie Service GmbH
10882 Berlin
Zertifizierungsstelle für Maschinen

Dokumentationsbeauftragter/ Christiane Nitschak
Documentation manager
Autorisé à constituer le dossier technique

Aachen, den 27.07.2016

Dipl.-Ing. Walter Zander
Geschäftsführung
General Manager
Director

Dipl.-Ing. Alfons Auerhoff
Leiter CE-Konformitätsbewertung
Manager for EC declaration of conformity
Responsable évaluation de conformité CE

H. ZANDER GmbH & Co. KG • Am Gut Wolf 15 • 52070 Aachen • Germany
Tel: +49 (0)241 9105010 • Fax: +49 (0)241 91050138 • info@zander-aachen.de • www.zander-aachen.de

PT 3/0020