

MINOS SL



Operating Instructions



Product Safety
Functional
Safety

www.tuv.com
ID: 0655000100

Safety Modules MINOS SL

Zander GmbH & Co. KG
Am Gut Wolf 15
52070 Aachen, Germany
info@zander-aachen.de
www.zander-aachen.de

Version: J07 Ver.B E61-345-00

Engl. translation

Subject to technical modifications,
no responsibility is accepted for the
accuracy of this information.

Contents

1. Scope.....	5
2. Target group	5
3. Safety instructions.....	5
4. Appropriate use.....	6
5. Disclaimer and warranty.....	7
6. Features.....	7
7. Variants.....	7
8. Function	8
9. Application examples	9
10. Mounting	12
11. Electrical connection	12
12. Commissioning	13
13. Checks and maintenance.....	14
14. Pin assignment and LED displays.....	15
15. Wiring / Applications.....	16
16. Time diagrams	22
17. Test-Pulses / Variant SLxE	24
18. Monitoring table	26
19. Dimensions	29
20. Safety parameters.....	29
21. Technical data.....	31
22. Derating	34
23. Variants / Ordering-No.	35
24. Service.....	37
25. Declaration of conformity	38

1. Scope

This document is valid for the following safety modules:

MINOS SL1D (Order-No.: 472800-472803)

MINOS SL2D (Order-No.: 472804-472807)

MINOS SL1E (Order-No.: 472820-472823)

MINOS SL2E (Order-No.: 472824-472827)

2. Target group

Specialist electricians and assembly, setup and service specialists who possess special knowledge in working with safety components.

3. Safety instructions



Safety components are intended to protect people. Not following the safety instructions, improper installation or manipulation may result in fatal injuries to persons and damage to property. Safety devices must not be bypassed, removed or manipulated in any way. Please follow all the safety instructions and warnings mentioned in this document:

Installation, commissioning, maintenance, and decommissioning should be done only by authorised and qualified technicians,

- who are familiar with proper handling of the safety components,
- who are familiar with the applicable EMC and ESD regulations,
- who are familiar with the local regulations concerning work safety and accident prevention
- who have read and understood these operating instructions.

The user shall be responsible for integrating the device into a safe overall system. For this purpose, the overall system has to be validated, e.g. according to EN ISO 13849-2.

Opening the device, any kind of manipulation to it and bypassing the safety devices are not permitted.

The device version (see nameplate "Ver.") should be stored and checked before every commissioning. If there is a version change, the use of the device in the overall application should be revalidated.

4. Appropriate use

MINOS SL are safety emergency stop modules for monitoring emergency stop buttons, safety doors and light curtains, as well as contact reinforcement of safe outputs (e.g. safe PLC outputs) to machines and plants. The modules are also certified for continuous operation in furnaces according to EN 50156-1 / EN 746-2.

The approved operating parameters for use must be complied with (see section "technical data").

A risk assessment should be carried out on the machine before using the device. For example, according to:

EN ISO 13849-1, Safety-related parts of control systems, Appendix A

EN ISO 12100, Safety of machinery - General principals for design - Risk assessment and risk reduction

IEC 62061, Safety of machinery - Functional safety of safety-related electrical, electronic and programmable electronic control systems

Additional requirements may have to be considered depending on the type of machine or plant.

Appropriate use also includes compliance with EN ISO 13849-1, Safety-related parts of controllers,

EN 60204-1, Electrical equipment in machines.

For further information please refer to the above mentioned documents.



Note!

- The user is responsible for integrating the device into a safe overall system. For this purpose, the overall system has to be validated, e.g. according to EN ISO 13849-2
- If a operating instruction is enclosed with the product, then the specifications given in the operating instruction are applicable

5. Disclaimer and warranty

If the above mentioned conditions for appropriate use are not complied with or if the safety instructions are not followed or if any maintenance operations are not carried out as required, this shall lead to an exclusion of liability and loss of warranty.

6. Features

- Use up to PL e, Cat. 4, SILCL3 (depending on variant)
- Stop Category 0 according to EN 60204-1
- 1 two-channel safe input
- 1 safe solid-state output (PNP)
- 1 auxiliary output (PNP)
- Automatic or monitored manual start
- 6.2 mm width
- Extensive monitoring via front LED's

7. Variants

A number of variants allow a wide range of applications (see the sections "Application examples", "Wiring / application" as well as "Variants table / ordering codes").

Distinction is basically made between the two versions SLxD and SLxE:

SLxE:

Variant for max. requirements up to PL e / SILCL 3. Test pulses at the safe output enable error detection during operation.

SLxD:

Variant for requirements up to PL d / SILCL 2. No test pulses at the safe output. Specially suitable for controlling sensitive actuators.

8. Function

Safety circuit I1 / I2:

The safety circuit is designed to be used as single or dual channel via I1 and I2 depending on the variant and wiring (see page 16 "Wiring / applications - safety circuit").

Start input S21:

A monitored manual start or an automatic start is provided via the terminal S21 depending on the variant (see page 18 "Wiring / applications - start-up behaviour").

Note: The start function is determined by the respective variant (see page 35 "Variants / ordering codes").

Safe output O1:

Considering the start-up behaviour, the safe solid-state output switches on at the time the safety circuit closes. Opening the safety circuit results in an immediate shutdown (safe condition).

Auxiliary output C1:

The PNP-semiconductor output switches invertedly to the safe output.

Behaviour in case of a fault:

It is ensured that one single fault does not lead to loss of the safety function and that every fault is detected latest when the system is switched off and switched on again through cyclic self-monitoring.

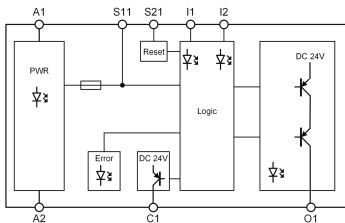

Fig. 1 Block diagram of MINOS SL

9. Application examples

Application example 1:

Two-channel emergency-stop monitoring with short circuit monitoring and monitored manual start

- SL1E: Up to PL e / SILCL 3
- SL1D: Up to PL d / SILCL 2

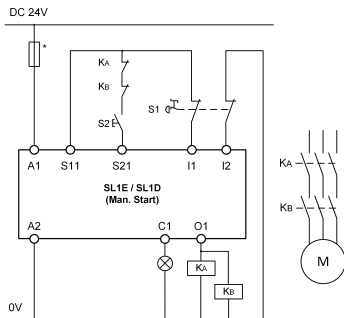

Fig. 2 Application example - Two-channel emergency-stop monitoring with short circuit monitoring and monitored manual start

Application example 2:

Single-channel emergency stop monitoring with automatic start

- SL2E: Up to PL c / SILCL 1
- SL2D: Up to PL c / SILCL 1

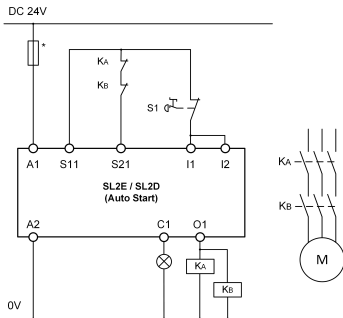

Fig. 3 Application example - Single-channel emergency stop monitoring

10. Mounting

The device has to be installed in a cabinet having minimum protection class of IP54:

- Mount on a 35 mm mounting rail as per EN 60715
- Ensure adequate heat dissipation in the cabinet
- The mounting distance to the adjacent devices depends on the load at the safe output O1. See section "Technical data - Safe solid-state output O1" and "Derating"

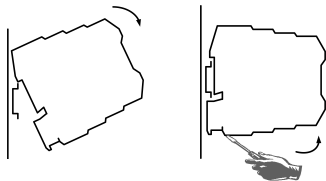

Fig. 7 Mounting / Demounting

11. Electrical connection

- Wiring should only be carried out while the voltage supply is switched off
- Do not connect any external voltages to the outputs
- The outputs C1/O1 are short-circuit-proof. Overloading is not allowed and results in damage to the device. (see chapter 21 "Technical data")
- All inductive loads should have adequate protection circuit such as a free-wheeling diode
- Auxiliary outputs may not be used as safety outputs
- All electrical connections must either be isolated from the mains supply by safety transformers (SELV/PELV) according to IEC 61558-2-6 with limited output voltage in the event of a fault, or by other equivalent isolation measures

CAUTION:

In case of a dangerous failure, the MINOS generates a short-circuit in the MINOS-Power-Supply. An upstream fuse will set the MINOS

into safe state (Safety output is switched off). According to Fig. 1 the MINOS already has an internal fuse (3 A, fast acting), which ensures this protection.

An additional, external fusing according to Fig. 19 is necessary, if the used power supply does not have enough power for tripping the internal fuse. In that case take the following into account:

- Nominal current: $I_N = I_{out} + 120 \text{ mA}$
- Characteristic: Fast acting

To guarantee the tripping of the internal or external fuse, use a power supply which is able to supply fourfold of the nominal current of the fuse.

In case of the "Automatic start" variants, O1 immediately switches on when the safety circuit is closing.



The monitored manual start of the device should not be used to start the machine in accordance with EN ISO 13849-1.

12. Commissioning

1. Wiring the safety circuit:

Wire the safety circuit according to your application, as well as the required safety levels determined (see Fig. 9 to 14).

2. Wiring the start circuit:

Wire the start circuit as shown in Fig. 15 or 17.

3. Wiring the feedback circuit:

If your application requires external contactors or expansion modules, connect them to the device according to Fig. 16 or 18.

4. Wiring the power supply:

Connect the power supply to the terminals A1 and A2 (Fig. 19).

Tip: Install a fuse < 3 A, fast acting in front of terminal A1 during initial commissioning. This prevents unintentional tripping of the fuse integrated in the MINOS SL due to wiring errors.

5. Starting the device:

Switch on the operating voltage. The LED UB starts lighting immediately. If the "Automatic start" behaviour is set, the safe output with closed safety circuit switches on immediately.

If "monitored manual start" is set, press and release the start button after closing the safety circuits to enable the safe output.

The LEDs **I1**, **I2** and **O1** start glowing.

6. Triggering the safety function:

Open the safety circuit. The safe output switches off immediately. The LEDs **I1**, **I2** and **O1** are off.

7. Switching on again:

Restart the device.

13. Checks and maintenance

The following checks are regularly required to ensure proper and continuous functioning:

- Check the switching function
- Check for signs of manipulation and safety function bypassing
- Check if the device is mounted and connected securely
- Check for soiling

Check if the safety device is working properly, in particular:

- Every time after initial commissioning

- Every time after replacing a component
- After a long downtime
- After every fault

Regardless of this, the safe functioning of the safety device should be checked at suitable intervals, e.g. as part of the maintenance schedule of the plant. No maintenance is required for the device itself.



Proper operation is no longer guaranteed if the device is damaged, e.g. after a fault. Replace the device in such cases. Only the manufacturer may repair the device and open the housing.

14. Pin assignment and LED display















	A1: Power supply + 24 V	
	S11: DC 24 V control voltage	
	S21: Control line start	
	I1: Control line safety circuit 1	
SL1E	SLxx: Variant label (see variant table)	
		
	Monitoring LED: Err (see monitoring table)	
A1 ↑	Label - Upper terminal block	
S11 ↑		
S21		
I1	Label - Lower terminal block	
I2		
O1		
C1		
A2 ↓	Monitoring LEDs: UB, I1, I2, O1 (see monitoring table)	
UB 		
I1 		
I2 		
O1 	I2: Control line safety circuit 2	
		O1: Safe output
		
		
	C1: Auxiliary output	
	A2: Power supply 0 V	

Fig. 8 Front view

15. Wiring / Applications

Depending on application and variant or result of the risk assessment, e.g. according to EN ISO 13849-1, the device should be wired according to Fig. 9 to 21.

Safety circuit

Dual-channel emergency stop or safety door monitoring with short circuit monitoring.

Up to PL e / SILCL 3

For variants: SL1D (472800 - 472803)

SL1E (472820 - 472823)

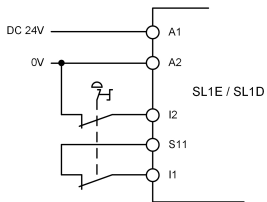

Fig. 9: Potential-free NC contacts dual channel

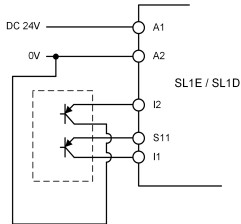

Fig. 10 PNP solid-state outputs dual channel

Safety circuit

Single-channel emergency stop or safety door monitoring with earth fault monitoring.

Up to PL c / SILCL 1

For variants: SL2D (472804 - 472807)
SL2E (472824 - 472827)

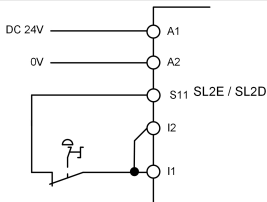

Fig. 11: Potential-free NC contact single channel

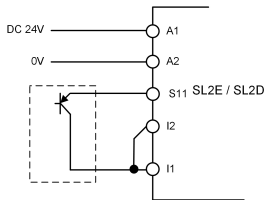

Fig. 12 PNP solid-state output single channel

Safety circuit

Dual-channel monitoring of safe OSSD outputs with integrated short circuit monitoring.

Up to PL e / SILCL 3

For variants: SL2D (472804 - 472807)
SL2E (472824 - 472827)

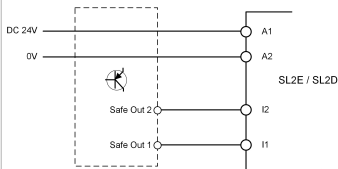

Fig. 13 OSSD outputs dual channel

Safety circuit

Single-channel monitoring of safe OSSD output.

Up to PL e / SILCL 3

For variants: SL2D (472804 - 472807)
SL2E (472824 - 472827)

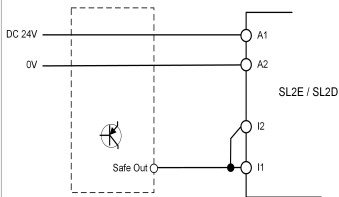

Fig. 14 OSSD outputs single channel

Note

Fault exclusion of a short circuit in the safety circuit according EN ISO 13849-2.

Start behaviour

Monitored manual start without feedback circuit. Any contactors connected to O1 are not monitored.

Note: Evaluation of the falling edge of the start signal.

For variants: SL1D (472800 - 472801)
SL2D (472804 - 472805)
SL1E (472820 - 472821)
SL2E (472824 - 472825)

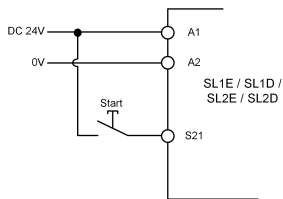

Fig. 15 Manual start without feedback circuit

Start behaviour

Monitored manual start with feedback circuit.

Note: Evaluation of the falling edge of the start signal.

For variants: SL1D (472800 - 472801)
 SL2D (472804 - 472805)
 SL1E (472820 - 472821)
 SL2E (472824 - 472825)

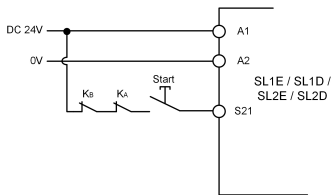

Fig. 16 Manual start with feedback circuit

KA, KB:

Positively driven NC contacts of the connected contactors or expansion modules.

Start behaviour

Automatic start. Any contactors connected to O1 are not monitored.

Note: Difference time monitoring:

I2 before I1: as desired

I1 before I2: max. 300 ms, otherwise a short signal on O1 or O1 does not switch.

For variants: SL1D (472802 - 472803)
 SL2D (472806 - 472807)
 SL1E (472822 - 472823)
 SL1E (472826 - 472827)

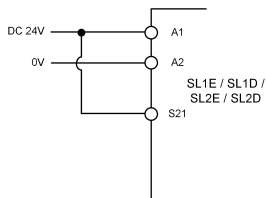

Fig. 17 Automatic start without feedback circuit

Start behaviour

Automatic start with feedback circuit.

Note: Difference time monitoring:

I2 before I1: as desired

I1 before I2: max. 300 ms, otherwise a short signal on O1 or O1 does not switch on.

For variants: SL1D (472802 - 472803)
 SL2D (472806 - 472807)
 SL1E (472822 - 472823)
 SL1E (472826 - 472827)

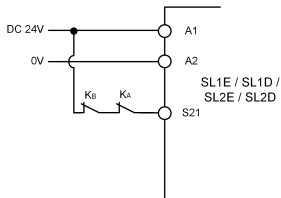

Fig. 18 Automatic start with feedback circuit

KA, KB:
 Positively driven NC contacts of the connected contactors or expansion modules.

Power supply

*Note *:*

See "Electrical connection" section on the use of an external fuse

For all variants of MINOS SL1D and SL1E.

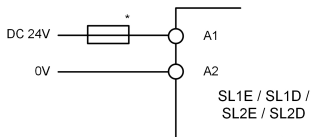

Fig. 19 DC 24 V power supply

Safe output

Suitable for inductive loads with interference suppression (contactors, valves,...) and resistive loads.

Note: Fault exclusion of a cross circuit should be carried out in the safety output, e.g. in accordance with EN ISO 13849-2, table D4/ D5 - Cables within an electrical installation space in accordance with EN 60204-1.

For all variants of MINOS SL1D and SL1E.

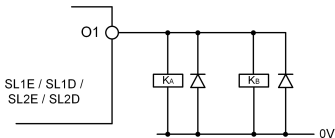

Fig. 20 Safe output

Auxiliary output

Suitable for indicator lamps or control inputs of connected PLC controllers.

For all variants of MINOS SL1D and SL1E.

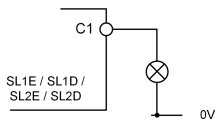

Fig. 21 Auxiliary output

16. Timing diagrams

SLxD and SLxE - Automatic start variant

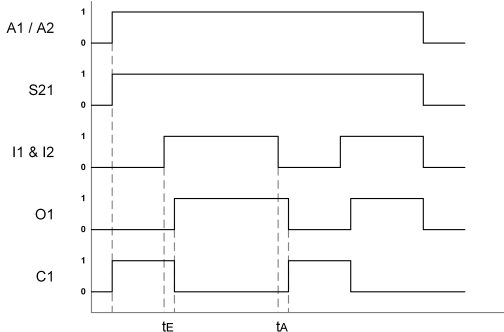

Fig. 22 Timing diagram - Automatic start

tE: Switch-on delay - 10 ms

tA: Switch-off delay - 12 ms

SLxD and SLxE - Monitored manual start variant

Fig. 23 Timing diagram - Monitored manual start

t_E : Switch-on delay - 10 ms

t_A : Switch-off delay - 12 ms

17. Test pulses - Variant SLxE

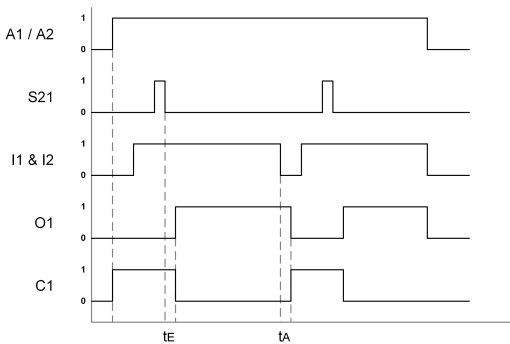
According to the monitoring requirements for safety relays up to PL e / SILCL 3, all the SLxE variants carry out an online test when enabled for the first time after every power-on, as well as cyclically once in 20 hours.

In these tests, the shutdown ability of the module is tested, which is indicated by short test signals at the safe output.

Test pulses during enabling after power-on

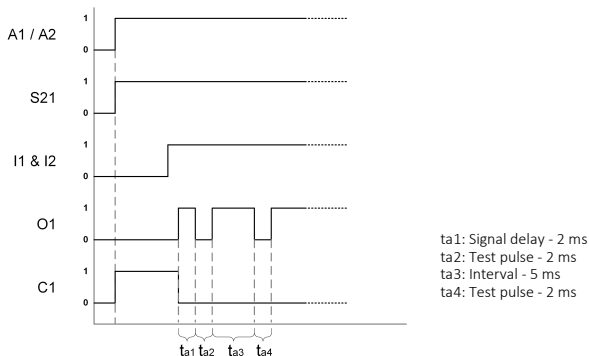

Fig. 24 Timing diagram - Test pulses during initial enabling - SLxE with automatic start

Online test in operation

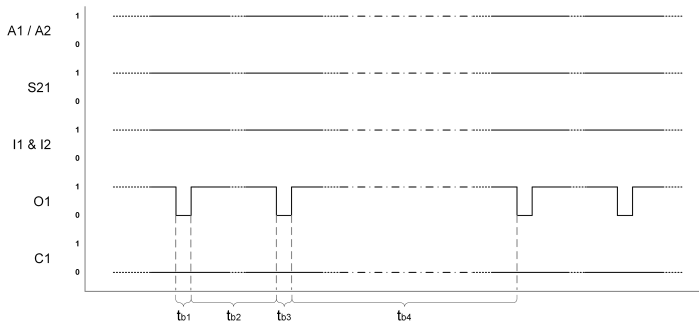

Fig. 25 Timing diagram - Test pulses in operation - SLxE

tb1: Test pulse 2 ms

tb2: Interval - 10 seconds

tb3: Test puls - 2 ms

tb4: Monitoring test cycle - 20 hours

NOTE:

Test pulses are not generated for the SLxD variants. Sensitive actuators that respond to the test pulses of the SLxE variants can be controlled with the SLxD variant.

18. Monitoring table

If the device does not respond as expected, a monitoring can be carried out using the front LEDs according to the table below.

LED off ○ LED on: ●					Explanation / Measure
Ub	I1	I2	O1	Err	
○	○	○	○	○	There is no supply voltage at the terminals A1/A2: ● Check the power supply
●	○	○	○	○	There are no signals at the safety circuit I1 and I2: ● Check the sensor at the input I1 and I2. Has an emergency stop been triggered or are safety doors open? ● Check if the sensor is working properly
●	●	○	○	○	Signal to the safety circuit I2 is missing: ● Check the sensor at the input I2. Has an emergency stop been triggered or are safety doors open? ● Check if the sensor is working properly
●	○	●	○	○	Signal to the safety circuit I1 is missing: ● Check the sensor at the input I1. Has an emergency stop been triggered or are safety doors open? ● Check if the sensor is working properly

LED off: ○ LED on: ●					Explanation / Measure
UB	I1	I2	O1	Err	
●	●	●	○	○	<p>The safe output is not enabled:</p> <ul style="list-style-type: none"> • Has the device been started properly? • Auto-start: Check if the reset circuit is connected to terminal S21 with UB. Check the synchronisation time between I1 and I2. If I1 is present before I2, then the maximum time between the two signals should not exceed 300 ms • Monitored manual start: Check the wiring of the Start button and perform a reset <p>Note: The falling edge of the start signal is evaluated.</p> <ul style="list-style-type: none"> • Feedback circuit not closed through some connected contactors or expansion modules. If so, replace the faulty device and perform a reset • Short circuit at safe output. If so, remove the short circuit, open and close the safety circuit. Press the Start button if necessary
●	○	●	○	●	<p>Short circuit in the safety circuit:</p> <ul style="list-style-type: none"> • Check the connected sensor and the wiring for short circuits
●	○	○	○	●	

LED off: ○ LED on: ●					Explanation / Measure
UB	I1	I2	O1	Err	
●	●	●	●	●	Overvoltage at A1/A2:
●	○	○	○	●	<ul style="list-style-type: none"> Measure the supply voltage. The maximum permissible supply voltage is 26.4 V DC
○	○	○	○	●	<p>A dangerous fault was detected. The internal fuse of the SL module has tripped, the device is no longer working.</p> <ul style="list-style-type: none"> Check the wiring of the safe output for any cross circuit or high capacitive load before replacing it (see section "Technical data") If one of these cases is true, first eliminate the fault and then install a new SL module

19. Dimensions

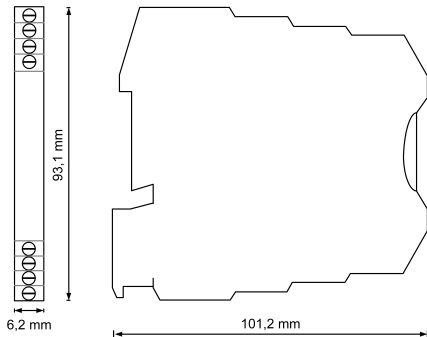

20. Safety parameters

CAUTION:



The switching cycle of the SLxD variants should be at least once a month.

If this is not already ensured by the application, then appropriate measures have to be taken for regular checks.

The following table shows the safety parameters for the different wirings of the safety circuit according to chapter 15 "Wiring / Applications".

Safety parameters

Application	See figure	Type	T _M [a]	EN ISO 13849-1			EN 62061 / EN 61508		
				PL	Cat	PFH [1/h]	SIL	PFD _{AVG}	PFH [1/h]
Dual-channel emergency stop circuit, safety door monitoring with short circuit monitoring	Fig. 9 and Fig. 10	SL1D	20	d	3	1.01E-07	2	1E-03	1E-07
		SL1E	20	e	4	9.06E-10	3	4.56E-07	5.21E-12
Single-channel emergency stop circuit with earth fault monitoring	Fig. 11 and Fig.12	SL2D	20	c	1	1.14E-06	1	1E-02	1E-06
		SL2E	20	c	1	1.14E-06	1	1E-02	1E-06
Dual-channel control via OSSD outputs with integrated short circuit monitoring	Fig. 13	SL2D	20	d	3	1.01E-07	2	1E-03	1E-07
		SL2E	20	e	4	9.06E-10	3	4.56E-07	5.21E-12
Single-channel control via safe OSSD output without fault exclusion of a short circuit in the safety circuit	Fig. 14	SL2D	20	c	1	1.14E-06	1	1E-02	1E-06
		SL2E	20	c	1	1.14E-06	1	1E-02	1E-06
Single-channel control via safe OSSD output with fault exclusion of a cross circuit in the safety circuit according to EN ISO 13849-2	Fig. 14	SL2D	20	d	3	1.01E-07	2	1E-03	1E-07
		SL2D	20	e	4	9.06E-10	3	4.56E-07	5.21E-12

21. Technical data

Standards

Meets the following standards	EN ISO 13849-1; IEC 62061; IEC 61508; EN 50156-1; EN 746-2/IEC 61511-1; EN 60204-1
-------------------------------	---

Electrical data

Operating voltage	U _B : DC 24 V ± 10 %
Power consumption at U _B = 24 V (Module enabled via S11. No load.)	1.8 W
Fusing the operating voltage	See chapter "Electrical connection"

Safe dual-channel input I1 / I2

Input current at high level	max. 7 mA
Galvanic isolation	no
Low level / high level	0 to 5 V / 18 V to U _B
Pulse suppression - Signal to 0V (Variants SL2D and SL2E)	6 ms
Max signal width till system locks	> 50 ms

Start input / feedback circuit S21

Input current at high level	max. 9 mA
Galvanic isolation	no
Low level / high level	0 to 5 V / 18 V to U _B

Safe solid-state output O1

Structure	PNP output; redundant; diverse
Maximum switching capacity at U _B :	2.5 A - see derating characteristics in chapter 22

Safe solid-state output O1

Maximum capacitive load at O1:

- SLxE - Variants	$C_{max} = 4.7 \text{ nF} + I_{O1} * 6000 \text{ nF/A}$
- SLxD - Variants	any
Test pulses - Cycle / signal length (SLxE - variant)	20 hours / 2 ms; Accuracy: $\pm 5 \%$
Galvanic isolation	no
Short-circuit-proof	yes
Output voltage at "1" (max. load) / "0"	$U_B - 1 \text{ V} / 0,1 \text{ V}$

Auxiliary output C1

Structure	PNP output, single channel
Maximum switching capacity	100 mA
Galvanic isolation	no
Short-circuit-proof	yes
Output voltage at "1" (max. load) / "0"	$U_B - 2 \text{ V} / 0 \text{ V}$

Timings

Time till module is ready for operation after power-on	50 ms
Max. switch-on delay	10 ms
Off-delay	
- if requested via the safety circuit	< 13 ms
- in case of Pwr-Off	0 s (Supply for O1 is U_B)
Recovery time after shutdown via request through the safety circuit or Pwr-Off	50 ms

Ambient temperature	-15 °C to 55 °C - see Derating characteristics in chapter 22
Storage temperature	-15 °C to 80 °C
Humidity rating	93 % relative humidity at + 40 °C, non-condensing
Vibration / Shocks	10 Hz to 150 Hz / 0.5 g
EMC	in accordance with EN 61326-3-1

Environmental data

Clearance and creepage distances in accordance with EN 60664-1	According EN 60664-1
Overvoltage category	III (in accordance with DIN VDE 0110-1)
Pollution degree	2 (in accordance with DIN VDE 0110-1)
Rated insulation voltage	50 V
Rated impulse withstanding voltage	800 V

Mechanical data

Degree of protection	IP20
Minimum degree of protection of installation space	IP54
Mounting	DIN rail
Installation position	vertical, horizontal
Dimensions (W x H x D)	6.2 x 93.1 x 102.5 mm
Weight	50 g (module without packaging)
Housing material	PBT, blue

Connection data - Screw terminals

Cross section of conductor	
- Rigid / flexible	0.2 to 2.5 mm ²
- AWG min/max	16/14
Insulation stripping length	12 mm
Tightening moment	0.5 to 0.6 Nm

Connection data - tensile spring terminals

Cross section of conductor	
- Rigid / flexible	0.2 to 2.5 mm ²
- AWG min/max	24/14
Insulation stripping length	8 mm

22. Derating

Maximum current at the safe output O1 depending on the ambient temperature.

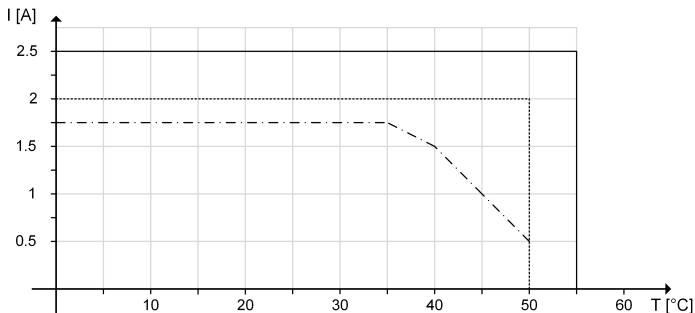

Fig. 26 Derating curve

- Free-standing with no adjacent devices (Free-standing \triangleq min. 30 mm clearance)
- 5 mm clearance to adjacent devices with same load
- · - · - 0 mm clearance to adjacent devices with same load

Caution:

In case of overvoltage at U_B up to 10% the max. output current at O1 have to be reduced by 0.5 A.

23. Variants / Order No.

MINOS SLxD

Order No.	Identification*	Variant configuration			
		Terminals	Application	Start behaviour	Max. PL / SILCL
472800	<u>SL1D</u>	Tensile spring	Dual-channel emergency stop or safety door monitoring	Man. Start	PL d / SILCL 2
472801	<u>SL1D</u>	Screw	Dual-channel emergency stop or safety door monitoring	Man. Start	PL d / SILCL 2
472802	<u>SL1D</u>	Tensile spring	Dual-channel emergency stop or safety door monitoring	Auto-Start	PL d / SILCL 2
472803	<u>SL1D</u>	Screw	Dual-channel emergency stop or safety door monitoring	Auto-Start	PL d / SILCL 2
472804	<u>SL2D</u>	Tensile spring	Light curtains; Contact amplification; OSSD; single-channel emergency stop	Man. Start	PL d / SILCL 2
472805	<u>SL2D</u>	Screw	Light curtains; Contact amplification; OSSD; single-channel emergency stop	Man. Start	PL d / SILCL 2
472806	<u>SL2D</u>	Tensile spring	Light curtains; Contact amplification; OSSD; single-channel emergency stop	Auto-Start	PL d / SILCL 2
472807	<u>SL2D</u>	Screw	Light curtains; Contact amplification; OSSD; single-channel emergency stop	Auto-Start	PL d / SILCL 2

* Label at the front of the device

MINOS SLxE

Order No.	Identification*	Variant configuration			
		Terminals	Application	Start behaviour	Max. PL / SILCL
472820	<u>SL1E</u>	Tensile spring	Dual-channel emergency stop or safety door monitoring	Man. Start	PL e / SILCL 3
472821	<u>SL1E</u>	Screw	Dual-channel emergency stop or safety door monitoring	Man. Start	PL e / SILCL 3
472822	<u>SL1E</u>	Tensile spring	Dual-channel emergency stop or safety door monitoring	Auto-Start	PL e / SILCL 3
472823	<u>SL1E</u>	Screw	Dual-channel emergency stop or safety door monitoring	Auto-Start	PL e / SILCL 3
472824	<u>SL2E</u>	Tensile spring	Light curtains; Contact amplification; OSSD; single-channel emergency stop	Man. Start	PL e / SILCL 3
472825	<u>SL2E</u>	Screw	Light curtains; Contact amplification; OSSD; single-channel emergency stop	Man. Start	PL e / SILCL 3
472826	<u>SL2E</u>	Tensile spring	Light curtains; Contact amplification; OSSD; single-channel emergency stop	Auto-Start	PL e / SILCL 3
472827	<u>SL2E</u>	Screw	Light curtains; Contact amplification; OSSD; single-channel emergency stop	Auto-Start	PL e / SILCL 3

* Label at the front of the device

24. Service

For service requirements, contact
H. Zander GmbH & Co. KG
Am Gut Wolf 15
52070 Aachen
Germany

Service line
+49 241 910 501-0

E-mail
info@zander-aachen.de

Internet
www.zander-aachen.de

25. Declaration of conformity



Konformitätserklärung
EC Declaration of Conformity
Déclaration de conformité



Hersteller:

Producer: H. ZANDER GmbH & Co. KG
 Fabricant: Am Gut Wolf 15 • 52070 Aachen • Deutschland

Produktgruppe:

Product Group: Sicherheits-Not-Halt-Schaltgeräte
 Groups de produits: Safety emergency stop switching devices
 Relais de sécurité d'arrêt d'urgence

Produkt Name

Product Name
 Nom du produit

Anbringung der CE-Kennzeichnung

Affixing of CE marking:
 Application du marque CE

SLxy (x =1,2; y =D,E).....201701/205/65667.00/17

Zertifikats-Nr.

No of Certificate
 N° du certificat

Die Produkte stimmen mit den Vorschriften folgender Europäischer Richtlinien überein:

The products conform with the essential protection requirements of the following European directives:
Les produits sont conformes aux dispositions des directives européennes suivantes:

2006/42/EG : Maschinenrichtlinie
2006/42/EG : Machinery directive
2006/42/EG : Directive Machines

2011/65/EU: RoHS Richtlinie
2011/65/EU: RoHS directive
2011/65/EU: Directive RoHS

2014/30/EU : EMV Richtlinie
2014/30/EU : EMC directive
2014/30/EU : Directive CEM

Die Übereinstimmung der bezeichneten Produkte mit den Vorschriften der o.a. Richtlinie wird, falls anwendbar, nachgewiesen durch die vollständige Einhaltung folgender Normen:

If applicable, the conformity of the designated products is proved by full compliance with the following standards:
Le strict respect des norms suivantes confirme, s'il y a lieu, que les produits désignés sont conformes aux dispositions de la directive susmentionnée:

EN 60947-5-1:2010-04
DIN EN 61326-3-1:2008-11

EN 61000-6-2:2006-03

EN 61000-6-3:2011-09

Gemäß Zertifikat der benannten Stelle:

According to the certificate of the below mentioned organisation:
Selon de organisme notifié:

DIN EN ISO 13849-1:2015
IEC 61508 Parts 1-2 and 4-7:2010
EN 50156-1:2015 in extracts

EN 62061:2016

IEC 61511-1:2016 in extracts

EN 746-2:2010 in extracts

Benannte Stelle / Organisme notifié: Nr. NB 0035

TÜV Rheinland Industrie Service GmbH
10882 Berlin

Zertifizierungsstelle für Maschinen

Dokumentationsbeauftragter/-r: Christiane Nitschak
Documentation manager
Autorisée à constituer le dossier technique



Dipl.-Ing. Alfons Austerhoff
Leiter CE-Konformitätsbewertung
Manager for EC declaration of conformity
Responsable évaluation de conformité CE

Aachen, den 07.07.2017



Dipl.-Ing. Walter Zander
Geschäftsleitung
General Manager
Director

H. ZANDER GmbH & Co. KG • Am Gut Wolf 15 • 52070 Aachen • Germany
Tel +49 (0)241 9105010 • Fax +49 (0)241 91050138 • info@zander-aachen.de • www.zander-aachen.de

FT-3-07/03

