

I N S T R U C T I O N M A N U A L

F O R

R E S I S T I V E L E V E L M E A S U R E M E N T



M O D E L : L R 4 2 0



Issued 2015-02-18

Read and understand this manual for safe use.

- This manual applies to products for general purpose. For use in hazardous areas, select products approved for the area classification and see its associated manual.
- This manual contains important information on handling, inspection and adjustment of the model indicated on the cover page. Read and fully understand this manual before use.
- Follow instructions given by NOHKEN or its representative, since their instructions have higher priority than those in this manual.
- Keep this manual within easy access.
- Specifications in this manual may not be satisfied depending on application conditions. Check the conditions carefully before use.
- Contact our sales office for any questions or comments about this manual or the product.

The meaning of the terms and symbols used in this manual is as follows:

 WARNING	Indicates a potentially hazardous situation which, if necessary precautions are not observed, could result in death, serious injury or disaster.
 CAUTION	Indicates a hazardous situation which, if necessary precautions are not observed, may result in minor or moderate injury or damage to the device.

	Means prohibited actions. Always follow instructions with this mark.
	Means actions that must be taken. Always follow instructions with this mark.

 **WARNING**

This product is not designed for use in hazardous areas. Do not use it in a place where flammable gas or vapor is present. Failure to observe this may result in ignition of flammable gas or vapor, causing a disaster. In hazardous areas, select a product approved for the area classification.

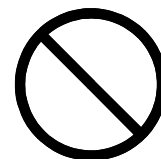

Do not modify or disassemble the product. Failure to observe this may result in faulty operation, damaged product, human injury or electric shock. (Please note that instructions given by Nohken or its representative have higher priority than those in this manual.)

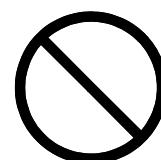

Disconnect power before wiring or inspection. Failure to observe this may result in ignition or electric shock due to leak or shortcircuit.



Ensure correct wiring. Wrong wiring may cause the product or connected equipment to malfunction, be damaged, or ignite, and may also result in electric shock or user injury.



Disconnect power immediately in the event smoke, unusual smell or sound is sensed. Do not use the product until problems are solved.



 **CAUTION**

Do not drop, knock off, throw, drag or give a strong shock to the product to avoid damage.

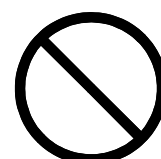

Always use the product within specified operating conditions. Failure to observe this may cause the product or connected equipment to malfunction, be damaged, or ignite, and may also result in electric shock or user injury.

See the instruction manual or spec sheets for specifications.



Test the product before actual use and ensure correct operation. Install a back-up device of a different technology if failure of the product is expected to result in a serious accident.





CAUTION

Carefully check material compatibility. Note that components with thin surface such as a float can malfunction even with a minor corrosion.



When carrying, mounting or removing the product from the tank, hold the flange or the threaded connection (or somewhere close to it), and not the housing. Otherwise the housing may be separated and the rest of the product may drop, resulting in product damage or user injury.



For product of 50cm or longer

Do not stand the product but lay it to avoid damage to the product or things around it, and user injury when it falls over.



Provide an arrestor or a surge absorber to protect the product from a lightning or static electricity. Failure to observe this may cause the product or connected equipment to malfunction, be damaged, or ignite, and may also result in electric shock or user injury.



INTRODUCTION

- A) This manual applies to standard models. Information in this manual may not be applied to special models.
- B) We are willing to help customers to select a suitable model or provide information about chemical compatibility of materials used, but the final decision is to be made by the customer.
- C) We always welcome suggestions and comments about the manual. Please contact our sales office when you have questions or comments.
- D) For replacement parts:
The product quality is regularly reviewed and improved, so the same spare parts may not be available. In this case, replacement parts or products may be supplied. Please contact our sales office for detail.
- E) The contents of this manual are subject to change without prior notice in the course of further development.

WARRANTY & DISCLAIMER

- A) NOHKEN warrants this product against defect in design, material and workmanship for a period of one (1) year from the date of original factory shipment.
- B) NOHKEN does not assume any liability for consequential damages.
- C) NOHKEN does not assume any liability for damages resulting from:
 - C-a) not observing the instructions in this manual;
 - C-b) installation, wiring, operation, maintenance, inspection, or storing in a manner not outlined in this manual;
 - C-c) modifications or repairs done by an unauthorized person;
 - C-d) use or replacement with parts not provided by NOHKEN;
 - C-e) devices or machine from other manufacturer;
 - C-f) unintended use (see "Purpose of use" in chapter 1 in this manual);
 - C-g) force majeure including, but not limited to, fire, earthquake, tsunami, lightning, riots, commotion, war, radioactive pollution, acts of God, acts of government or governmental authorities, compliance with law, regulation, or order.

THE TERMS OF WARRANTY AND DISCLAIMER IN NO WAY LIMIT YOUR LEGAL RIGHTS.

Table of Contents

1. PURPOSE OF USE	1
2. PRINCIPLE OF OPERATION	1
3. SPECIFICATIONS	2
3.1 Model Numbering	2
3.2 Specifications	2
3.3 Specifications per model	2
4. PART NAME	3
5. HANDLING NOTES	4
6. INSTALLATION	5
6.1 Unpacking	5
6.2 Mounting	7
7. WIRING	8
7.1 Before Wiring	8
7.2 Cable Inlet	8
7.3 Wiring	8
7.4 Placing the Cover	10
8. MAINTENANCE AND INSPECTION	11
8.1 Removing the Sensor	11
8.2 Maintenance Procedure	12
8.3 Mounting	12
8.4 Wiring	12
9. STORING	13
10. TROUBLESHOOTING	14
11. GLOSSARY	15

1. PURPOSE OF USE

Resistive Level Measurement LR420 is a dc powered instrument to continuously monitor liquid levels.

The sensor measures resistance that changes along with the liquid level, and converts the resistance into an electric signal (2 wire, 4 to 20mA DC) to offer level monitoring.

Do not use the sensor for any other purpose.

2. PRINCIPLE OF OPERATION

The sensor comprises of a float* and a stem*. The float has a magnet* inside. The stem incorporates a circuit board with several Hall ICs* and resistors placed at regular intervals.

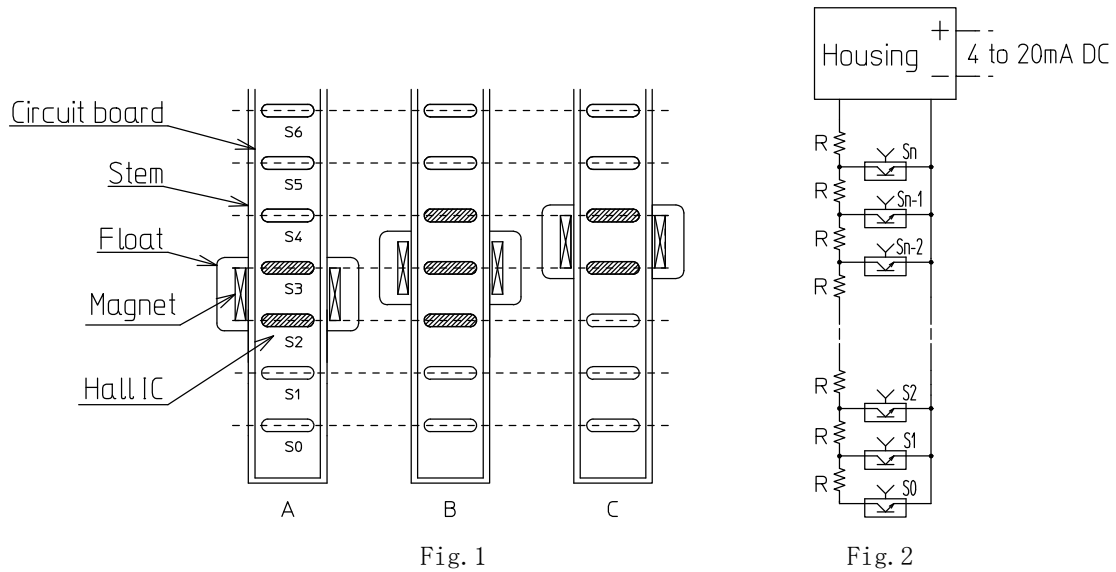

Fig.1 shows operation of the float and the Hall ICs. Fig.2 shows the circuit in the stem. For a rising level, float location and Hall ICs in operation change as shown in Fig.1, from A(2 ICs in operation) to B (3 ICs in operation), then to C (2 ICs in operation).

For a falling level, from C to B, then to A.

This means that the combined resistance changes as the float rises or falls.

The electronics in the sensor housing measures the combined resistance, converts it to signals, and then amplify and calibrate the signals to give current output (2 wire, 4 to 20mA DC).

* See 11. GLOSSARY.

3. SPECIFICATIONS

3.1 Model Numbering

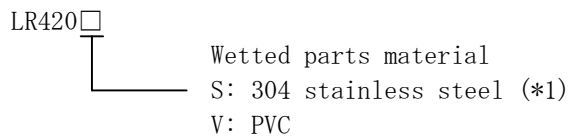

1 For LR420S, float is in 316 stainless steel and float travel stop in 316L stainless steel

3.2 Specifications

Operation characteristics		
Resolution	10mm	5mm
Accuracy	X	
	Measurement range = M	Measurement range M < 1500mm
	$X = \pm \sqrt{\left(\frac{15 \text{ (mm)}}{M \text{ (mm)}} \times 100\right)^2 + (0.5)^2} \text{ \%F. S.}$	$X = \pm \sqrt{\left(\frac{7.5 \text{ (mm)}}{M \text{ (mm)}} \times 100\right)^2 + (0.5)^2} \text{ \%F. S.}$
		Measurement range M ≥ 1500mm X = ± 0.71%F. S.
Hysteresis	±10mm	±5mm
Temperature characteristics	±50 ppm F. S. /°C	
Electric characteristics		
Power supply	18 to 28V DC	
Output	4 to 20mA DC	
Resistive load	<p>Loop resistance (Ω)</p> <p>720</p> <p>560</p> <p>320</p> <p>18 24 28 (V DC)</p> <p>Operating area</p> <p>Supplied voltage</p>	

3.3 Specifications per model

Model	LR420S	LR420V
Flange* size	JIS 5K 50A	JIS 5K 80A or equivalent
Stem	φ 13.8	φ 22
Float size	φ 49×H50	φ 65×H80
Withstand pressure (static pressure)	2 MPa Max. (except process connection)	200 kPa Max. (except process connection)
Working temperature		
Wetted parts	-10 to +100°C (no freezing)	0 to +50°C
Electronics	-10 to +50°C (no dew condensation)	-10 to +50°C (no dew condensation)
Humidity (electronics)	85% RH Max.	85% RH Max.
Protection class*	IP65	IP43
Specific gravity	0.8 Min.	0.7 Min.
Cable inlet	G 3/4 or equivalent	G 3/4 or equivalent

* See 11. GLOSSARY.

4. PART NAME

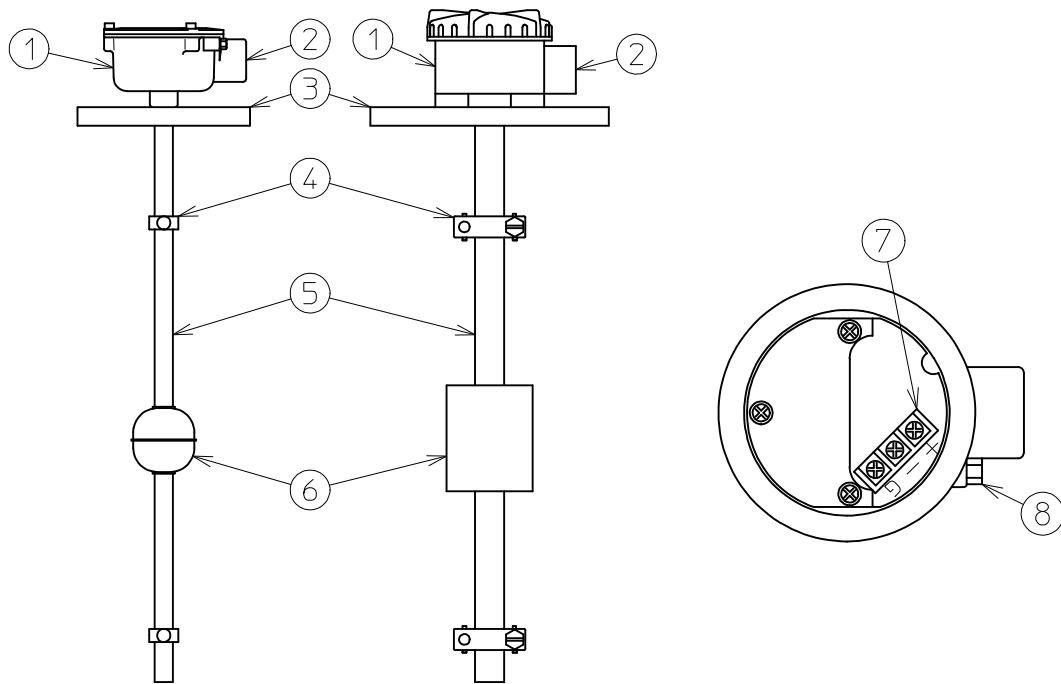

① Housing

② Cable inlet

③ Flange

④ Float travel stop

⑤ Stem

⑥ Float

⑦ Terminal block

⑧ External earth terminal (metal housing only)

5. HANDLING NOTES

Observe instructions below when handling the sensor, or faulty operation or user injury may result.

- 5.1 Lay the sensor on a flat surface. If stood, the sensor may fall over and be damaged.
 Support the sensor with wood pieces for example, to avoid rolling, bent stem, or damaged float.
 For a sensor longer than 2000mm, support the stem at 1000mm intervals to avoid a sagged stem.

Correct

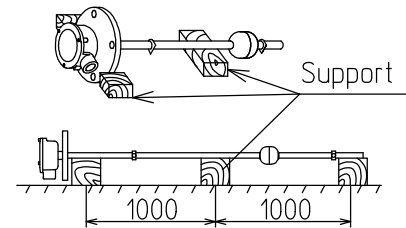

Incorrect

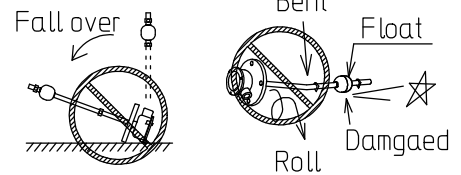

- 5.2 The nameplate contains maintenance and other important information. When painting the sensor, ensure such information is legible.

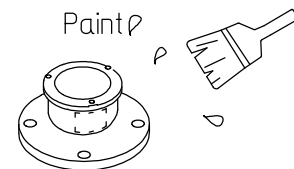

- 5.3 Avoid corrosive atmosphere (NH_3 , SO_2 , Cl_2).
 Such atmosphere can ingress into the housing and corrode the internal circuit, causing electrical continuity failure.

Corrosive atmosphere

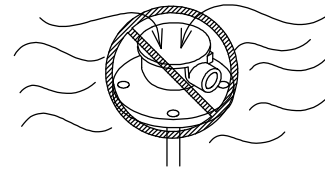

- 5.4 Avoid places where vibration is expected.
 If such location is inevitable, remove the source of vibration or protect the sensor from receiving the vibration.

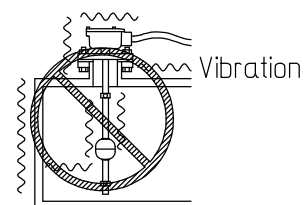

- 5.5 Avoid proximity to sources of a strong magnetic field (such as a large motor). The magnet inside the sensor may be adversely affected, and faulty operation may result.

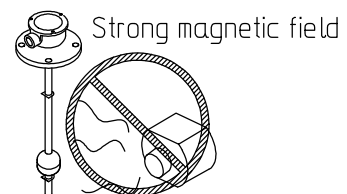

- 5.6 Do not use the sensor to measure liquids that include excessive amount of metal powder. Otherwise faulty operation may result since the sensor utilizes magnets.

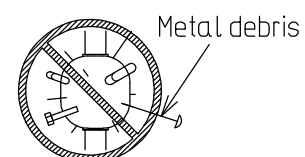

6. INSTALLATION



WARNING

This product is not of the explosion proof model*. Never use it in areas where flammable or explosive gases or vapors are expected to be generated. In hazardous areas, select a product approved for the area classification.



CAUTION

When carrying, mounting, or removing the sensor, hold it by the flange. Do not hold the sensor by the housing, or the housing may come off the flange to cause sensor damage or user injury.

Correct

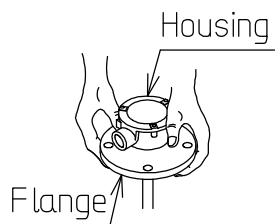

Incorrect

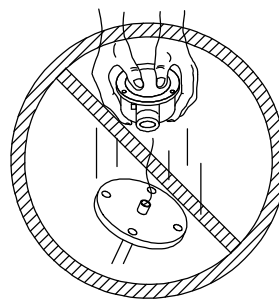

6.1 Unpacking

6.1.1 Open the package and take out the sensor.

Hold the stem by the portion close to the process connection, and somewhere else. This is to prevent a bent stem due to flange weight, or damaged Hall ICs or circuit boards inside the stem.

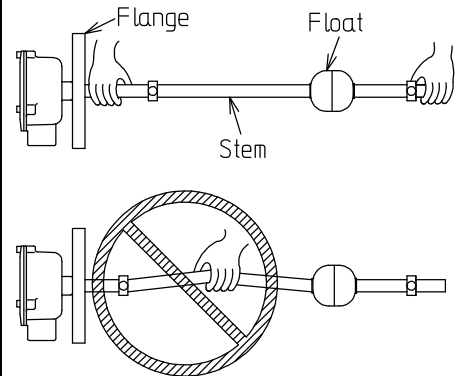

6.1.2 Do not drop, knock over, throw, crush or give a strong shock to the sensor to avoid damaging it.

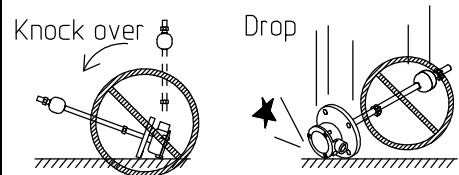

* See 11. GLOSSARY.

6.1.3 Completely remove packing materials such as tape, vinyl and cardboard to prevent faulty operation. After unwrapping the floats, tilt the sensor in a direction where the float will not slide down. Tilting the sensor even a little can move the float and cause it to hit the float travel stop. This may result in a damaged float, changed magnetic force, or a moved float travel stop.

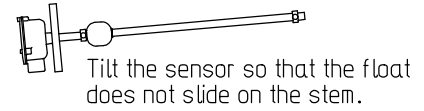
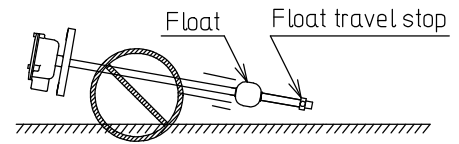

6.1.4 Do not place anything on the sensor to avoid a deformed or damaged sensor.

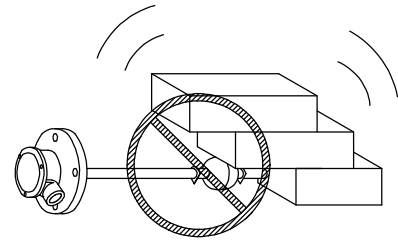

6.1.5 Check against nameplate that the sensor is as ordered. If not, please contact our sales office.

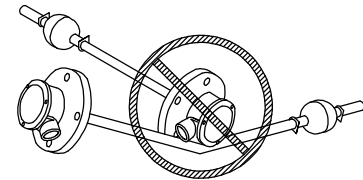

6.1.6 Check the sensor for visible damage. If any, it may have been caused during transport. Please contact our sales office.

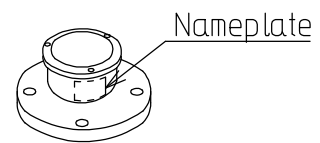

6.2 Mounting

6.2.1 Mounting Location

Ensure ample space around the mounting point for easy handling and maintenance. Note that the space above the tank must be large enough to contain overall length of the sensor. This must be ensured after mounting the sensor, for when maintenance is required.

When mounting, observe the following instructions. Failure to do so may result in faulty operation.

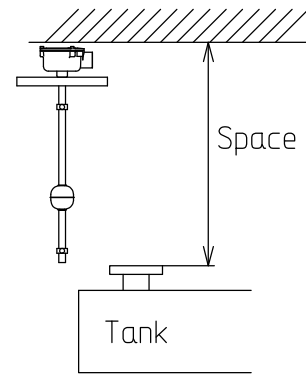

- (1) Avoid proximity to inlets or agitators that is susceptible to turbulence.

If such locations are not avoidable, use a stillpipe*. Ensure the stillpipe inner diameter is larger than outer diameter of the float+20mm. If smaller, float may contact the pipe wall and cause faulty operation. For a sensor longer than 1500mm, use a spacer* to prevent float from contacting the pipe wall.

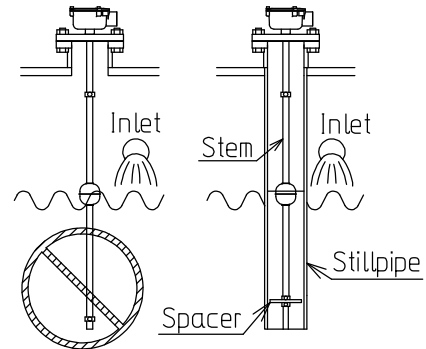

- (2) Avoid proximity to piping or other obstructions that can restrict float operation.

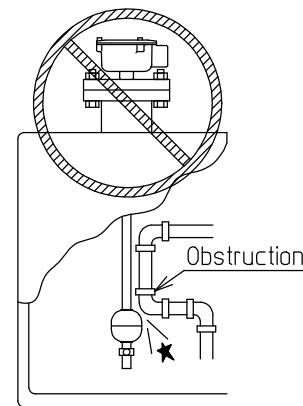

6.2.2 Mounting the Sensor

Fit the sensor flange to the tank flange, and using a proper tool, secure the flanges with bolts according to applicable standards. Ensure the sensor is mounted vertically. For pressure applications, use a gasket to avoid leak. Note that bolts and gaskets are optional parts.

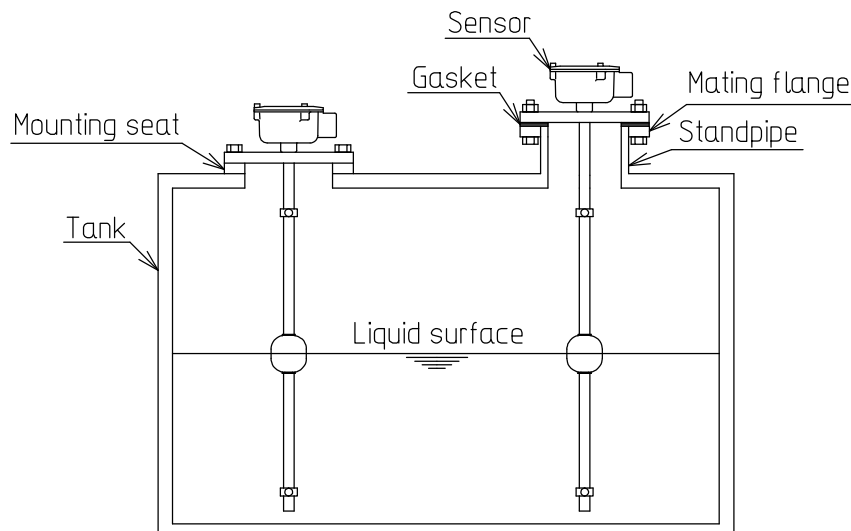



* Refer to 11. GLOSSARY.

7. WIRING

7.1 Before Wiring

7.1.1 Disconnect power to the cable used for the sensor.

	WARNING	
Disconnect power before wiring, or electric shock, leak, ignition or user injury due to short circuit may result.		

7.1.2 Remove the housing cover.

7.2 Cable Inlet

Cable inlet is of G 3/4 or equivalent.

Use a cable gland or a conduit to secure the cable. In both cases, lead the cable downward in front of the cable inlet to prevent water entry.

Secure the cable using sealing compound when a conduit is used, and by tightening the gland with a proper tool when a cable gland is used, to prevent entry of dust, debris or rain water into the housing. If water or moisture can enter from inside the conduit, putty the inside.

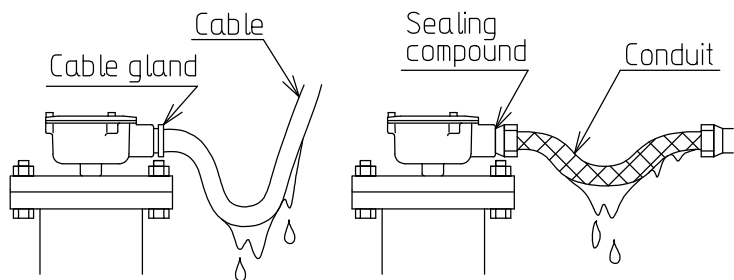

Correct

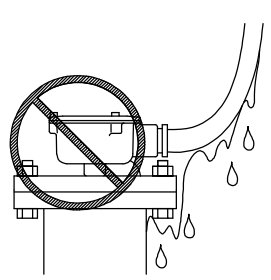

Incorrect



7.3 Wiring

	CAUTION	
Use shielded cable for the sensor input and output. Do not run the cable in line with power line or wiring for magnetic switches.		
Wire signal cable correctly and properly.		
Properly ground the external earth terminal. (Grounding resistance: 100Ω)		
Ensure loop resistance for output signal (4 to 20mA DC) is in the allowable operating area.		

7.3.1 Wire as shown below. Use a tool to tighten screws. Screws are of M3.5, so use a cable lug of R1.25-3.5 or an equivalent size.

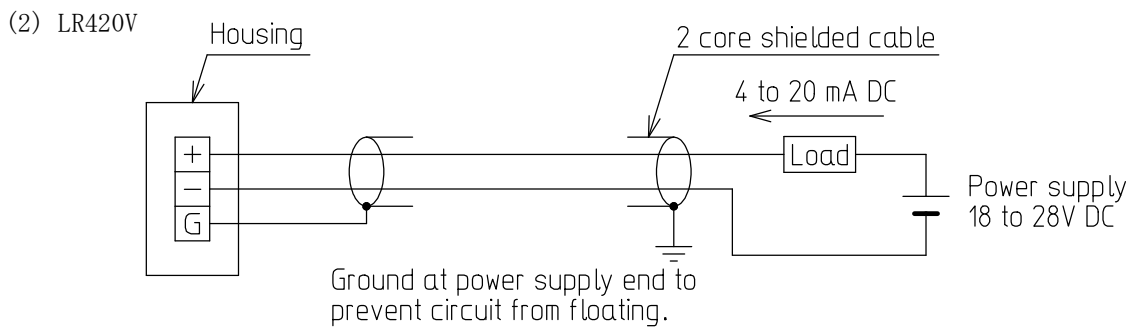
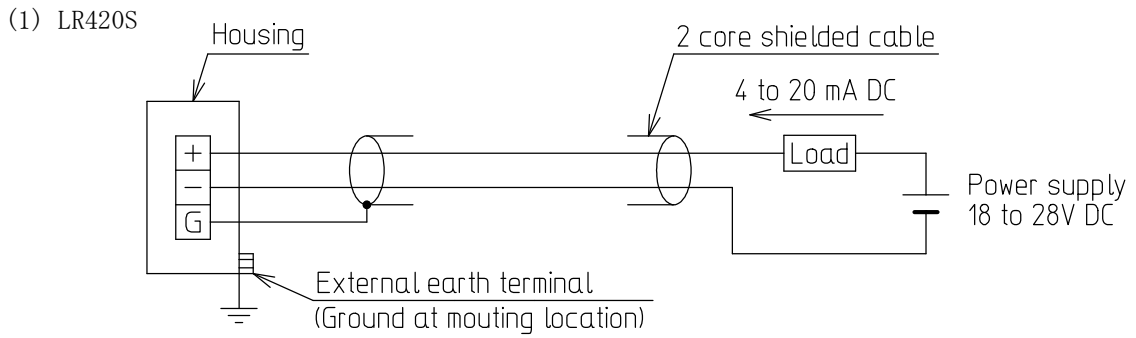

7.3.2 Connection to power unit PU2000

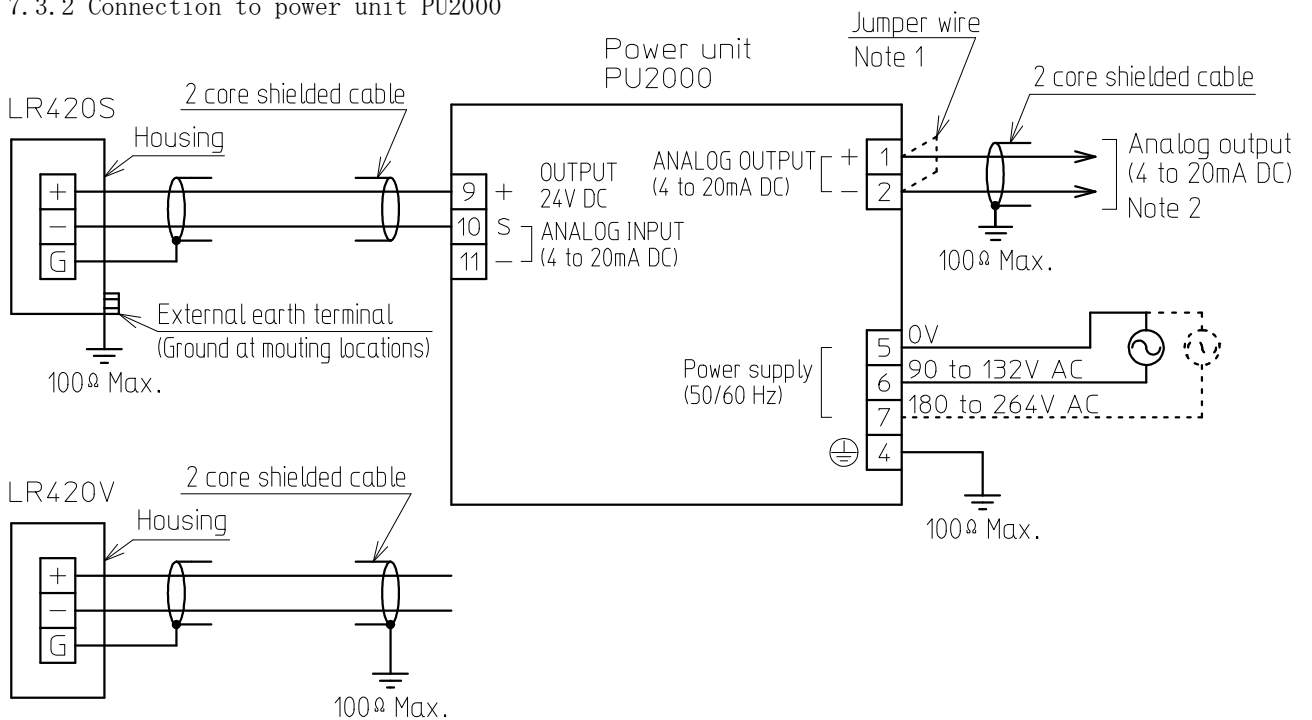

Notes:

1. Connect terminals 1 and 2 of PU2000 with jumper wire if no load is connected.
2. Do not ground the shield of analog output cable at the receiving end.
(No multipoint grounding)

7.4 Placing the Cover



Ensure a gasket is placed between the housing and the cover.
Without a gasket, water or dust may enter from the gap.

Remove dust or metal debris inside the housing. If left, metal debris can cause shortcircuit.
Ensure a gasket is placed on the cover, and then fit the cover.

For a housing cover fixed with screws, use a tool.

For a housing cover with threads, tighten the cover until it comes to a stop.

In either case, a loose cover may cause water or dust entry and cause corrosion, shortcircuit or faulty operation.

Remove
dust/debris.

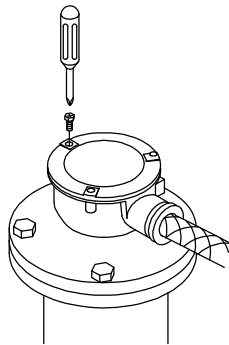
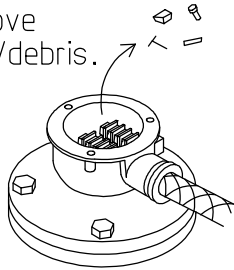

Tighten securely.

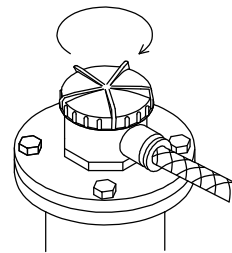

8. MAINTENANCE AND INSPECTION

Perform maintenance every half or one year. More frequent maintenance will be required depending on frequency of use, material type, temperature, pressure or other application conditions.

Remove the sensor from the tank before maintenance.

Read section 5. Handling Notes first. Ensure ample space for maintenance.

8.1 Removing the Sensor



WARNING

Disconnect power before maintenance, or electric shock, leak, or ignition or user injury due to short circuit may result.



- 8.1.1 Remove the housing cover, and disconnect cabling from the sensor.
Remove the conduit, if used.



CAUTION

When carrying, mounting, or removing the sensor, hold it by the flange. Do not hold the sensor by the housing, or the housing may come off the flange to cause sensor damage or user injury.

Correct

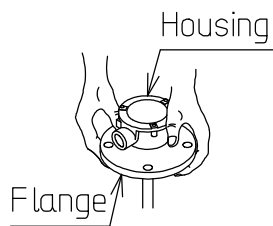

Incorrect

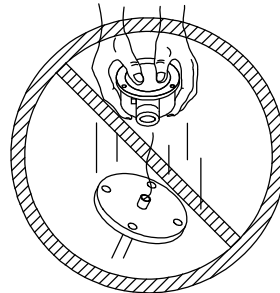

- 8.1.2 Remove bolts on the flange.

Hold the sensor by the flange, and remove the sensor from the tank.

- 8.1.3 Place the sensor on a flat surface.

8.2 Maintenance Procedure

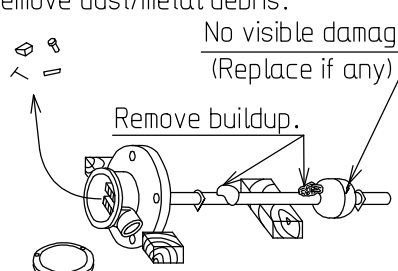
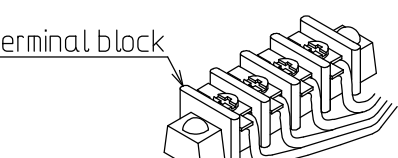
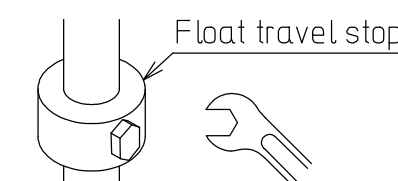
<p>8.2.1 Check the sensor for visible damage that may impair performance. Repair or replace if any.</p> <p>8.2.2 Check the float for buildup. Remove if any.</p> <p>8.2.3 Check the housing for condensation, foreign matter, dust, or metal debris. Remove if any.</p>	<p>Remove dust/metal debris.</p> <p>No visible damage (Replace if any)</p> <p>Remove buildup.</p> 
<p>8.2.4 Check terminals and lead wire for corrosion. Replace corroded components.</p>	<p>No corrosion.</p> <p>Terminal block</p> 
<p>8.2.5 Using a tool, ensure the float travel stop is properly secured. Retighten if loose.</p>	<p>Float travel stop</p> 

8.3 Mounting

See section 6.2 Mounting (p. 7).

8.4 Wiring

See section 7. Wiring (pp. 8 to 10).

9. STORING

Observe instructions below when storing the sensor after delivery before use, or after removing from the tank. Failure to do so can result in faulty operation.

9.1 Store the sensor in the following conditions.

- Temperature: -10 to +60°C
- Humidity: 85%RH Max.
- Atmosphere: not corrosive (without NH₃, SO₂, or Cl₂)
- No excessive vibration

9.2 Protect the sensor from rain or other water. The IP rating is achieved only when the sensor is mounted on a tank. In other cases, water can enter the housing.

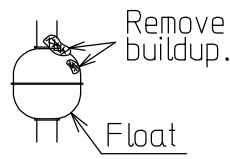
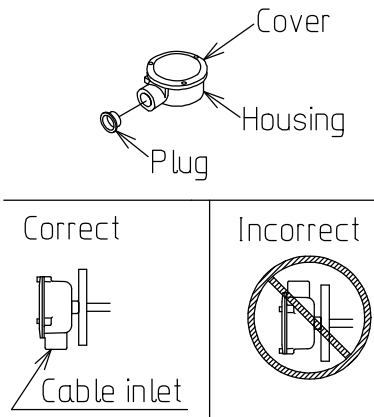
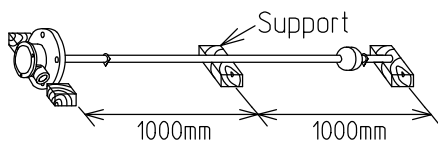
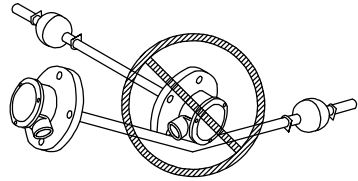
<p>9.3 Remove buildup. Be extra careful about floats since solidified buildup on a float may affect operation the next time used.</p>	
<p>9.4 Place the cover on the housing, and close the cable inlet with a plug. Otherwise dust may enter the housing. Place the housing so that the cable inlet points downwards.</p>	
<p>9.5 Support the sensor with, for example, wood pieces to prevent rolling, bent stem, or damaged float. For a sensor of 2000mm or longer, support the stem at 1000mm intervals to avoid sagged stem.</p>	
<p>9.6 Do not place anything on the sensor, or the sensor may deform or be damaged.</p>	

REFERENCE

Wrap the sensor with polyethylene sheet and seal it to protect the sensor from moisture or dust. If the sensor is stored where temperature change is enormous, enclose desiccant such as silica gel in the polyethylene sheet.

10. TROUBLESHOOTING



CAUTION

In the event of trouble, perform the following and nothing else.
If you have any question, please contact our sales office.

Trouble	Possible cause	Corrective action	Reference
Output is fixed at 4mA DC.	Buildup on float or stem.	Remove buildup.	
	Corrosion caused water entry inside float.	Check chemical compatibility. Replace stem and float with those compatible with the measured material.	
Output is fixed at 20mA DC.	Buildup on float or stem.	Remove buildup.	
	Float and float travel stop has fallen off the stem.	Replace the float and secure the float travel stop.	8.2 Maintenance procedure (p. 12)
Output is fixed at 0mA DC.	Loose or incorrect wiring.	Wire correctly.	7. Wiring (pp. 8 to 10)
	No power supplied.	Supply power.	7. Wiring (pp. 8 to 10)
No signal is given.	Buildup on float or stem.	Remove buildup.	
	Damaged circuit board due to noise or incorrect wiring.	Circuit board needs replacing. Please contact our sales office.	

11. GLOSSARY

Terms used in this manual are defined in the chart below. This chart excludes the terms having already been defined earlier in this manual.

Magnet	Component that creates a magnetic field to activate Hall ICs. Placed inside the float.
Float	Component that floats on liquid, and whose movement used to detect a liquid level.
Hall IC	Magnetic sensor that incorporates a transducer and a circuit. The transducer varies its output in response to a magnetic field, and the circuit converts signals.
Stem	Rod on which the float moves up and down. Incorporates a circuit board on which Hall ICs and resistors are arranged at regular intervals.
Float travel stop	Component that prevents the float from moving too far.
Flange	Circular component to mount the sensor on a tank using bolts and nuts.
Protection class	Degree of protection provided against the intrusion of solid object (including body parts) and water. Specified by IEC (IEC 529).
Explosion proof model	Model designed not to ignite explosive gases or vapor. Approved to be used in a hazardous area. (This manual is not for explosion proof models.)
Stillpipe	Pipe to protect the sensor from excessive turbulence or flow to prevent faulty operation.
Spacer	Circular component to prevent the float from contacting the stillpipe wall.

NOHKEN INC.

HEAD OFFICE : 15-29, Hiroshiba-cho, Suita-city, Osaka 564-0052, Japan.

TEL:06-6386-8141 FAX:06-6386-8140

TOKYO BRANCH OFFICE : 67, Kandasakumagashi, Chiyoda-ku, Tokyo 101-0026, Japan.

TEL:03-5835-3311 FAX:03-5835-3316

NAGOYA OFFICE : 3-10-17, Uchiyama, Chikusa-ku, Nagoya-city, Aichi 464-0075, Japan.

TEL:052-731-5751 FAX:052-731-5780

KYUSHU OFFICE : 14-1, 2-chome, Asano, Kokurakita-ku, Kitakyushu-city, Fukuoka 802-0001, Japan.

TEL:093-521-9830 FAX:093-521-9834