

Operating Instructions

English translation

Correct use

The multi-function timers DVC with analogue time setting offer all the standard functions and time domains in one device. Moreover, DVC can be used as a sensor relay. A remote potentiometer connection is also available.

DVC is intended for the control of time-sensitive processes at machineries and plants.

Features

- 16 functions:
- On-delay, signal off-delay, signal on- and off-delay, one shot actuation during starting, one shot actuation during stopping, one shot actuation during starting and stopping, flicker, one shot actuation, pulse shaping, each in some cases also inverted, electronic sensor.
- 2 times - t1 and t2 - available , 4 time ranges:
- 0.3-3s; 1-10s; 0.1-1min; 1-10min;
- The time range t1 and t2 are independent of each other.
- 2 operating voltages:
- AC 230V (or AC 115V) and DC 12-30V
- 1 or 2 contacts
- Design with 1 or 2 change-over contacts, 2nd change-over contact optionally as instantaneous or 2nd time closing contact.



Function

Time Ranges

The desired time range is determined according to the following table using the selector switch 6,7 or 8,9. The time at the end position of the potentiometer t1 or t2 is given.

t1	t2
3s ^{6,7}	3s ^{8,9} ON/OFF
10s	10s
1min	1min
10min	10min

Functions

The functions "signal off-delay", "signal on- and off-delay", "wipe contact during stopping", "one shot actuation during starting and stopping", "pulse shaping" are controlled via a potential-free contact at Y1-Y2.

Every change of state at Y1-Y2 directly affects the connected time function irrespective of whether a preceding reset time has elapsed or not. All other time functions start when the operating voltage is applied.

Compilation of the functions see page 2.

Functions and time ranges cannot be altered once the operating voltage has been applied.

Special Function: Electronic Sensor

With the "electronic sensor" function connected to terminals Z1-Z2 drops below a certain level. The DVC can be used as a contact protection relay, sensor switching amplifier, temperature probe (with external PTC/NTC resistor) or twilight switch (with external LDR resistor) in this mode of operation.

Contacts

The devices have two change-over contacts. The second contact can be optionally switched as a time closing or instantaneous contact (switch 1):

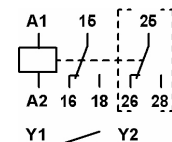
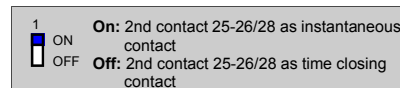

Safety Precautions



- The installation and operation must be carried out by qualified personnel only,
- who is familiar with the professional handling of machine equipment,
- who is familiar with the valid rules of industrial safety and accident prevention,
- who read and understood the operating instructions.
- The safe function of the device during machine operation cannot be guaranteed in case of wrong connection or improper operation. This may lead to fatal injuries.
- Pay attention to country specific regulations.
- The electrical installation must be performed after disconnecting the device and the machine from the mains supply.

- The wiring must be carried out according to the instructions of this operating manual.
- The person who programs the device must be protected against electrostatic discharge (ESD protection).
- Opening the device, any manipulation of the device and the avoidance of the safety facilities are not permitted.
- All relevant safety regulations and standards must be attended to.
- Non-observance of the safety regulations may cause death, severe injuries or substantial damage to property.
- Before use, please, read the operating instructions and keep it in a safe place. Make sure that the operating instructions are always available for installation, initial operation and maintenance.

Non-observance of the instructions above will cause the loss of warranty.

Functions and Applications

On-delay

Contact 15-16 (25-26) switches after operating voltage is applied to A1-A2 (or B1-B2) and time lapse (t1) to 15-18 (25-28).

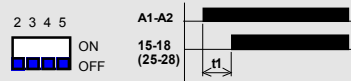

One shot actuation (starting)

Contact 15-16 (25-26) switches after operating voltage is applied to A1-A2 (or B1-B2) for the duration of the set time t1 to 15-18 (25-28).

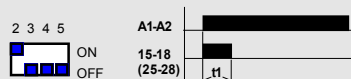

Flicker

When voltage is applied to A1-A2 (B1-B2) the relay alternately switches on at time t2 and switches off at time t1, starting with the pause time t1.

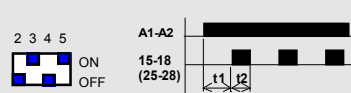

The function can be inverted with switch 2 = ON (start with working time).

One shot actuation

Contact 15-16 (25-26) switches after operating voltage is applied to A1-A2 (or B1-B2) and time lapse t1 for the time of t2 to 15-18 (25-28).

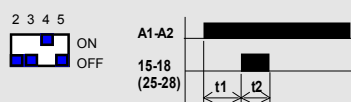

The function can be inverted with switch 2 = ON.

Signal off-delay

Contact 15-16 (25-26) switches after the potential-free contact closes at Y1-Y2 to 15-18 (25-28). When Y1-Y2 opens the off-delay time t1 starts, after which the contact switches back to 15-16 (25-26).

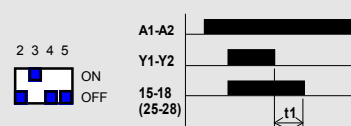

The function can be inverted with switch 2 = ON.

Signal on- and off-delay

If Y1-Y2 is connected via a potential-free contact, contact 15-16 (25-26) switches on expiry of t1 to 15-18 (25-28). When Y1-Y2 opens the time lapse t2 starts the off-delay, after which the contact switches back to 15-16 (25-26).

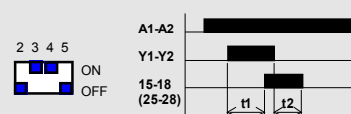

The function can be inverted with switch 2 = ON.

One shot actuation (stopping)

If the closed potential-free contact at Y1-Y2 is opened, contact 15-16 (25-26) switches to 15-18 (25-28) for the duration t1.

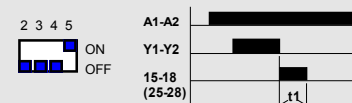

The function can be inverted with switch 2 = ON.

One shot actuation during starting and stopping

Contact 15-16 (25-26) switches to 15-18 (25-28) for the time t1 after the potential-free contact closes at Y1-Y2. Once Y1-Y2 opens the contact 15-16 (25-26) switches to 15-18 (25-28) for the duration t2.

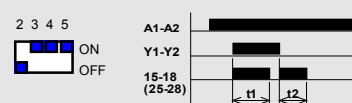

Pulse shaping

Contact 15-16 (25-26) switches to 15-18 (25-28) for the duration t when the potential-free contact closes at Y1-Y2 irrespective of whether the potential-free contact is opened before or after expiry of the time t1.

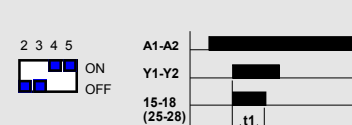

The function can be inverted with switch 2 = ON.

Electronic sensor

Contact 15-16 (25-26) switches to 15-18 (25-28) if an electrical resistance between terminals Z11-Z12 falls below a certain value. The switching threshold can be set on the front potentiometer t1. The hysteresis depends on the resistance value used.

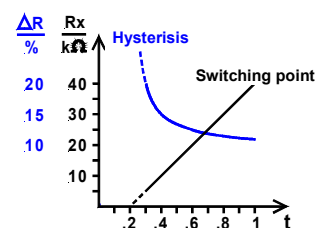
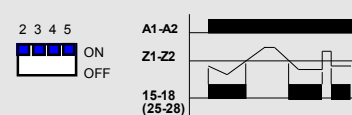

Operating Instructions

English translation

Installation

According to EN 60204-1 the unit is designed to be used in switch cabinets with a minimum environmental protection of IP54. The housing is designed to be mounted on a 35 mm DIN-rail according to DIN EN 60715 TH35.

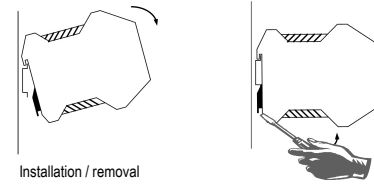

Installation / removal

Electrical connection

- Select function and time range at the DIL switch on the side of the device before applying operating voltage.
- A1-A2 are operating voltage connections for AC 230 V, B1-B2 for DC 12-30 V.
- If the DC 12-30 V version is used, a control transformer according to EN 61558-2-6 or a power supply unit with electrical isolation from the mains must be connected.
- External fusing of the contacts (6A slow-blow or 8 A quick-action) must be provided.
- The line cross section must not exceed 2.5 mm²
- If the device does not function after commissioning, it must be returned to the manufacturer unopened. Opening the device will void the warranty.

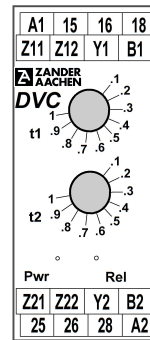

- A1: Power supply AC 230 V
- A2: Power supply AC 230 V
- B1: Power supply DC 12-30 V
- B2: Power supply DC 12-30V
- Y1: Control line time function
- Y2: Control line time function
- Z11: Control line remote poti t1
- Z12: Control line remote poti t1
- Z21: Control line remote poti t2
- Z22: Control line remote poti t2
- 15-16-18: Contact 1
- 25-26-28: Contact 2

Contact configuration

Maintenance

The device must be checked once per month for proper function and for signs of tampering.

The device is otherwise maintenance free, provided that it was installed properly.

Remote potentiometer

The remote potentiometer DFP 100 kOhm is available as an accessory with rotary knob, scale and mounting kit. If a remote potentiometer is connected the bridge between terminals Z11-Z12 and Z21-Z22 must be removed and the potentiometer on the front set to maximum.



Remote Potentiometer DFP

Techn. Data

Operating voltage	AC 230 V, 50-60 Hz and DC 12-30 V
Residual ripple	+ / - 10%
Power consumption	AC 3.5 VA, DC < 3 W
LED's	yellow: stand by green: relay contact 15-18 (25-28) switches on
Protection	IP20
Time ranges	0.3-3s; 1-10s; 0.1-10min; 1-10min
Input resistance sensor relay	5-40 kOhm
Repeat accuracy	+/- 0.5%
Reclose readiness	< 60 ms
Switching capacity	AC 250 V: max. 8 A, max. 2000 VA DC: 2 A at 24 VDC
Contact life	mechanical 2x10 ⁷ operations
Temperature dependence	0.1% /°C
Contact fuses	6 A slow-blow or 8 A quick-action
Max. line cross section	2.5 mm ²
Test voltage	2.5 kV (control voltage / contacts)
Dielectric strength, leakage path/air gap	4 kV (DIN VDE 0110-1)
Rated insulation voltage	250 V
Temperature range	-20 ⁰ - + 60 ⁰ C (dew-free)
Weight	approx. 200 g
Installation position	any, DIN-rail mounting

Dimensions

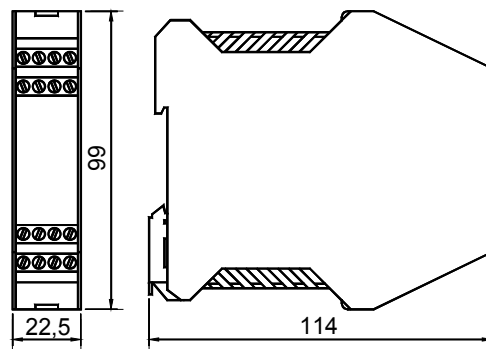

Variants

Order No. 416100	DVC AC 230V / DC 12-30V, 2 changeover contacts
Order No. 445091	Remote potentiometer DFP 100kOhm